

Faculdade de Engenharia da Universidade do Porto

# Computer Sound Transformations Guided by Perceptually Motivated Features

Nuno Figueiredo Pires



Master in Electrical and Computers Engineering

Supervisor: Professor Rui Luis Nogueira Penha

Second Supervisor: Dr. Gilberto Bernardes de Almeida

January 2018



# Resumo

Nesta dissertação, apresentamos uma revalidação de estudos feitos sobre descritores de som quente. A partir de um modelo existente, implementamos um algoritmo que define o *warmth* de um som harmónico monofónico. O algoritmo permite a produtores e a músicos, manipular o *warmth* de um áudio musical em tempo real (ou seja, performance ao vivo).

O termo *warmth* cai numa categoria de conceitos de atributos musicais, tais como "brilho", "aborrecido", "monótono", os quais músicos e produtores musicais adoptam quando se referem a atributos tímbricos do som. Esta léxico musical é bastante relevante para a comunidade de peritos musicais. Porém, devido à sua natureza subjetiva, é difícil definir um modelo matemático que nos permita manipular sons usando técnicas de processamento de sinal digital. Portanto, ao estarmos cientes da importância desta ferramenta de processamento, procuramos compreender os timbres que afetam tal atributo sónico informal e em segundo, codificá-la como um modelo matemático que possa ser utilizado para manipular o *warmth* the áudio musical em tempo real.

O descritor proposto manipula uma área de *warmth* calculada, que é baseada no trabalho de D. Williams [1], onde o *warmth* é uma relação entre a energia dos três primeiros harmónicos e a energia do resto do espectro do sinal. Para este fim, nós regulamos as amplitudes das componentes espectrais do áudio musical para moldá-los de acordo nível relativo de *warmth* controlado pelo utilizador. Por outras palavras, permitimos ao utilizador reduzir ou aumentar a percentagem de *warmthness* dinamicamente do áudio musical de entrada mantendo a relativas variações, em tempo real.

Para primeiro tentarmos perceber de que forma é que o *warmth* num som instrumental é percebido, realizamos uma avaliação perceptual que foi enviada para 128 pessoas com diferentes níveis de proficiência musical.

Por forma a validar e avaliar a eficácia da nossa aplicação, realizamos um segundo teste de escuta que contou com a participação de 51 indivíduos.

Concluimos que, apesar de termos conseguido correlacionar o *warmth* com a centroid espectral, o algoritmo tem de ser melhorado pois a diminuição do nível de *warmth* não é perceptível.



# Abstract

We present a revalidation of previous research done on description of warm sound. With an existing model, we elaborate an algorithm that defines the “warmth” of a monophonic harmonic sound. A twofold approach to the algorithm allows producers and musicians to not only measure this sound attribute but also manipulate it in real-time (i.e. a live performance).

The term warmth falls in a category of music audio attributes, such as bright, dull, flat, which expert musicians and music producers widely adopt to address timbral attributes of sound. This (semantic) musical jargon is highly relevant to the community of musical experts. Yet, due to its subjective nature, it’s hard to define mathematically, which would enable us to manipulate sounds using digital signal processing techniques. By being aware of the importance of such a processing tool, we strive here to first understand the timbral attributes which impact such an informal sonic attribute and second encode it as a mathematical model which can be used to manipulate the warmth of musical audio in real-time.

Based on the work of D. William and T. Brookes [1], the proposed warmth descriptor manipulates a certain “Warmth Region”, where this “warmth” is a relation between the energy of the first three harmonics and the energy of the remainder magnitude of the spectrum. To this end, we regulate the amplitudes of the spectral components of a musical audio, to shape them according to a relative user-controlled level of warmth. In other words, we allow the user to dynamically reduce or increase the percentage of warmthness in the musical audio input, while retaining the relative variability over time.

To first understand how warmth in instrumental sounds is perceived, we performed a perceptual evaluation, that was submitted to over 128 people of different levels of musical proficiency.

To validate and evaluate the effectiveness of the application we designed a second listening test that counted with the participation of 51 individuals.

We conclude that despite having a correlation between the warmth and the spectral centroid, the algorithm has to be improved as the decrease of warmth was not perceived.



# Acknowledgment

I start by thanking my supervisor Professor Rui Penha for giving me the opportunity to work on this dissertation. I thank you for all the support and feedback given throughout this work. Ever since I discovered the class of Advanced Synthesis of Sound I decided that I would like to do my thesis with Professor Rui Penha, where I could join electrical an computer engineering and audio. I'd also like to thank my INESC-TEC supervisor Gilberto Bernardes for his tireless support, for always being available to teach me and correct my wrong doings and whose orientation was crucial for the completion of this thesis.

I thank all the elements of the Sound and Music Computing group for the meetings where we shared knowledge and brainstormed.

I'd also like to thank all my colleagues who accompanied me in this long journey, in particular to: Diogo "Souma" Sebe for his companionship and for all the delicacies you cooked at @Cisco's; to the "owners" of the @Cisco's Francisco "Cisco" Alpoim for all the moments during this endeavor and for helping reviewing this document; Diogo "Paquetón" Dias for his friendship and support; Joni "7kratos" Gonçalves for keeping us in check whenever we got together at @Cisco's and for making me realize that FEUP really affects a person :). I'd also like to thank Alexandre "Russo" Pires, Joaquim "Quim" Ribeiro, Pedro "kun" Dinis and Fábio "Beer Guy" Vasconcelos for this final years and all laughable moments.

I'd like to give a special thanks to all my family that supported me all this years, specially to my godmother.

A very special and heartfelt thank you to my sister Ana for putting up with me all these years and for being my partner and friend. To my dear parents for always going further and beyond and doing the impossible for my well being and personal growth. Thank you mother for being my guardian angel and, despite the difficult moments, being there to guide me and help me overcome incoming obstacles. Thank you father for being my Superman and for supporting me and helping me all my life and for being my strength and guiding me during this past few months. Thank you both for allowing and helping me close this important chapter of my life and I hope to count on your advice and support from now on too.

Once again, thank you all!

Nuno Figueiredo Pires



*“Failures, repeated failures,  
are finger posts on the road  
to achievement. One fails  
forward toward success.”*

C. S. Lewis



# Contents

|          |   |           |
|----------|---|-----------|
| <b>1</b> | <b>Introduction</b>   | <b>1</b>  |
| 1.1      | Context . . . . .   | 1         |
| 1.2      | Motivation . . . . .  | 1         |
| 1.3      | Goals . . . . .   | 2         |
| 1.4      | Document Structure . . . . .                                    | 2         |
| <b>2</b> | <b>Overview of Digital Audio Processing</b>                     | <b>3</b>  |
| 2.1      | Digital Signal Processing . . . . .                             | 3         |
| 2.2      | Music Information Retrieval . . . . .                           | 5         |
| 2.3      | Content-based audio description . . . . .                       | 6         |
| 2.3.1    | Low-Level Descriptors . . . . .                                 | 6         |
| 2.3.2    | Mid-Level Descriptors . . . . .                                 | 6         |
| 2.3.3    | High-Level Descriptors . . . . .                                | 7         |
| 2.3.4    | From Low-Level to Mid-Level to High-Level Descriptors . . . . . | 7         |
| 2.4      | Taxonomy of low-level audio descriptors . . . . .               | 8         |
| 2.4.1    | Temporal Energy Envelope . . . . .                              | 8         |
| 2.4.2    | Spectral Features . . . . .                                     | 9         |
| 2.4.3    | Sinusoidal Harmonic Partial . . . . .                           | 11        |
| 2.5      | Description of Sound Warmth . . . . .                           | 12        |
| 2.5.1    | Williams and Brookes' Metric . . . . .                          | 12        |
| 2.5.1.1  | Warmth Region . . . . .   | 12        |
| 2.5.2    | Aurélian's Metric . . . . .                                     | 13        |
| <b>3</b> | <b>Accessing the perceptual manifestation of sound warmth</b>   | <b>15</b> |
| 3.1      | Perceptual Evaluation . . . . .                                 | 15        |
| 3.1.1    | Listening Test . . . . .  | 15        |
| 3.1.2    | Results . . . . .   | 16        |
| 3.2      | Analysis of the instrumental sounds . . . . .                   | 17        |
| <b>4</b> | <b>Development of the system</b>                                | <b>25</b> |
| 4.1      | System Overview . . . . .                                       | 25        |
| 4.2      | Definition of the Warmth Region . . . . .                       | 25        |
| 4.3      | Resynthesis . . . . .   | 27        |
| 4.3.1    | Crossfade . . . . .   | 28        |
| <b>5</b> | <b>Evaluation of the system</b>                                 | <b>29</b> |
| 5.1      | Listening Test . . . . .  | 29        |
| 5.2      | Results . . . . .   | 30        |

|          |  |            |
|----------|--|------------|
| 5.3      | Analysis of the manipulated instrumental sounds . . . . .                      | 33         |
| <b>6</b> | <b>Conclusion and Future Work</b>  | <b>37</b>  |
| 6.1      | Summary . . . . .  | 37         |
| 6.2      | Conclusion and Future work . . . . .   | 37         |
| <b>A</b> | <b>Appendix</b>  | <b>39</b>  |
| A.1      | Pure Data Code . . . . .   | 39         |
| A.2      | Print screens and charts of the 1st listening test . . . . .                   | 44         |
| A.3      | Matlab plots of the results of the first listening test . . . . .              | 51         |
| A.4      | Print screens charts and plots relative to the second listening test . . . . . | 64         |
| A.5      | Matlab plots of the results of the second listening test . . . . .             | 71         |
|          | <b>References</b>  | <b>105</b> |

# List of Figures

|     |  |    |
|-----|--|----|
| 2.1 | Digital Audio Processing [9] . . . . .   | 4  |
| 2.2 | Analog-to-Digital Conversion [10] . . . . .  | 5  |
| 2.3 | Layers of audio analysis based on [16] . . . . .   | 7  |
| 2.4 | Table of descriptor by G. Peeters [25] . . . . .   | 9  |
| 2.5 | Architecture of Williams and Brookes' sound warmth descriptor . . . . .  | 13 |
| 2.6 | Definition of the Warmth Region . . . . .  | 13 |
| 3.1 | Responses of the first listening test with a graphical color code representation   | 17 |
| 3.2 | Values of the spectral centroid of the violoncello C3 and oboe C6 sounds . .   | 20 |
| 3.3 | Values of warmth of the violoncello C3 and oboe C6 sounds . . . . .  | 20 |
| 3.4 | Linear regression between the weighted arithmetic mean evaluation and the spectral centroid of all instrumental sounds . . . . .                         | 21 |
| 3.5 | Linear regression between the weighted arithmetic mean evaluation and the warmth of all instrumental sounds . . . . .                                    | 21 |
| 3.6 | Linear regression between the warmth and the spectral centroid of all instrumental sounds . . . . .  | 23 |
| 4.1 | System Architecture . . . . .  | 26 |
| 4.2 | First three harmonics of a Viola C4 sound . . . . .  | 27 |
| 4.3 | Example of a window with overlap of four blocks . . . . .  | 27 |
| 4.4 | Band-pass filter where only the values within the warmth region are allowed, and the rest is attenuated . . . . .  | 28 |
| 4.5 | Reject-band filter where the amplitudes within the warmth region are attenuated . . . . .  | 28 |
| 5.1 | Responses of the second listening test with a graphical color code representation . . . . .  | 30 |
| 5.2 | Values of the Spectral Centroid of the oboe C5 with 0%,+25% and +50% warmth . . . . .  | 34 |
| 5.3 | Values of the Spectral Centroid of the oboe C5 with 0%, -25% and -50% warmth . . . . .   | 35 |
| 5.4 | Values of the Spectral Centroid of the oboe C5 with 0%,+25% and +50% warmth . . . . .  | 36 |
| 5.5 | Values of the Spectral Centroid of the oboe C5 with 0%, -25% and -50% warmth . . . . .   | 36 |
| A.1 | Pure Data patch that receives the values of the Warmth Region and Spectral Centroid of all frames and calculates the mean, media, and standard deviation | 39 |
| A.2 | Pure Data patch that calculates the Warmth Region and the Spectral Centroid  | 40 |

|      |  |    |
|------|--|----|
| A.3  | Pure Data patch relative to the manipulation of the Warmth Region in real-time . . . . .   | 41 |
| A.4  | Pure Data patch that performs the FFT of the signal, applies a band-pass filter and reject-band filter in order to get part of the signal related to the Warmth Region and the Remainder Magnitude, respectively, and allow the manipulation of the Warmth Region . . . . .              | 42 |
| A.5  | Pure Data patch that performs the manipulation of the warmth region based on a user input . . . . .  | 43 |
| A.6  | Pure Data patch relative to the creation of an array with the first three harmonics of the signal . . . . .  | 43 |
| A.7  | Listening Test 1 - instructions, in portuguese, of how to answer the first listening . . . . .   | 44 |
| A.8  | Listening Test 1 - instructions, in English, of how to answer the first listening  | 45 |
| A.9  | Listening Test 1 - characterization of the participant . . . . .   | 46 |
| A.10 | Listening Test 1 - example of question where the participant has to evaluate the sound according to the categories. This same type of question was done for all the sample chosen in Table 3.1. . . . .  | 47 |
| A.11 | Response chart for all three tuba examples . . . . .   | 47 |
| A.12 | Response chart for all three horn examples . . . . .   | 48 |
| A.13 | Response chart for all three clarinet examples . . . . .   | 48 |
| A.14 | Response chart for all three oboe examples . . . . .   | 49 |
| A.15 | Response chart for all three viola examples . . . . .  | 49 |
| A.16 | Response chart for all three violoncello examples . . . . .  | 50 |
| A.17 | Variation of the value of warmth in each audio file . . . . .  | 51 |
| A.18 | Mean median and standard deviation of warmth in the three tuba sound examples. The leftmost (at '0') values belong to the sound of tuba C2. The values at '1' belongs to the sound of tuba C3 and the rightmost (at '2') values belong to the sound of tuba C4 . . . . .                 | 52 |
| A.19 | Variation of the value of the spectral centroid in each audio file . . . . .   | 52 |
| A.20 | Mean median and standard deviation of the spectral centroid in the three tuba sound examples. The leftmost (at '0') values belong to the of sound tuba C2. The values at '1' belongs to the sound of tuba C3 and the rightmost (at '2') values belong to the sound of tuba C4 . . . . .  | 53 |
| A.21 | Variation of the value of warmth in each audio file . . . . .  | 53 |
| A.22 | Mean median and standard deviation of warmth in the three horn sound examples. The leftmost (at '0') values belong to the sound of horn C2. The values at '1' belongs to the sound of horn C3 and the rightmost (at '2') values belong to the sound of horn C4 . . . . .                 | 54 |
| A.23 | Variation of the value of the spectral centroid in each audio file. . . . .  | 54 |
| A.24 | Mean median and standard deviation of the spectral centroid in the three horn sound examples. The leftmost (at '0') values belong to the of sound horn C2. The values at '1' belongs to the sound of horn C3 and the rightmost (at '2') values belong to the of sound horn C4 . . . . .  | 55 |
| A.25 | Variation of the value of warmth in each audio file . . . . .  | 55 |
| A.26 | Mean median and standard deviation of warmth in the three clarinet sound examples. The leftmost (at '0') values belong to the sound of clarinet C4. The values at '1' belongs to the sound of clarinet C5 and the rightmost (at '2') values belong to the sound of clarinet C6 . . . . . | 56 |

|      |  |    |
|------|--|----|
| A.27 | Variation of the value of the spectral centroid in each audio file . . . . .   | 56 |
| A.28 | Mean median and standard deviation of the spectral centroid in the three clarinet sound examples. The leftmost (at '0') values belong to the sound of clarinet C4. The values at '1' belongs to the sound of clarinet C5 and the rightmost (at '2') values belong to the sound of clarinet C6 . . . . .                              | 57 |
| A.29 | Variation of the value of warmth in each audio file . . . . .  | 57 |
| A.30 | Mean median and standard deviation of warmth in the three oboe sound examples. The leftmost (at '0') values belong to the sound of oboe C4. The values at '1' belongs to the sound of oboe C5 and the rightmost (at '2') values belong to the sound of oboe C6 . . . . .   | 58 |
| A.31 | Variation of the value of the spectral centroid in each audio file . . . . .   | 58 |
| A.32 | Mean median and standard deviation of the spectral centroid in the three oboe sound examples. The leftmost (at '0') values belong to the sound of oboe C4. The values at '1' belongs to the sound of oboe C5 and the rightmost (at '2') values belong to the sound of oboe C6 . . . . .  | 59 |
| A.33 | Variation of the value of warmth in each audio file . . . . .  | 59 |
| A.34 | Mean median and standard deviation of warmth in the three viola sound examples. The leftmost (at '0') values belong to the sound of viola C3. The values at '1' belongs to the sound of viola C4 and the rightmost (at '2') values belong to the sound of viola C5 . . . . .   | 60 |
| A.35 | Variation of the value of the spectral centroid in each audio file . . . . .   | 60 |
| A.36 | Mean median and standard deviation of the spectral centroid in the three viola sound examples. The leftmost (at '0') values belong to the sound of viola C3. The values at '1' belongs to the sound of viola C4 and the rightmost (at '2') values belong to the sound of viola C5 . . . . .  | 61 |
| A.37 | Variation of the value of warmth in each audio file . . . . .  | 61 |
| A.38 | Mean median and standard deviation of warmth in the three violoncello sound examples. The leftmost (at '0') values belong to the sound of violoncello C3. The values at '1' belongs to the sound of violoncello C4 and the rightmost (at '2') values belong to the sound of violoncello C5 . . . . .                                 | 62 |
| A.39 | Variation of the value of the spectral centroid in each audio file . . . . .   | 62 |
| A.40 | Mean median and standard deviation of the spectral centroid in the three violoncello sound examples. The leftmost (at '0') values belong to the sound of violoncello C3. The values at '1' belongs to the sound of violoncello C4 and the rightmost (at '2') values belong to the sound of violoncello C5 . . . . .                  | 63 |
| A.41 | Listening Test 2 - instructions, in portuguese, of how to answer the first listening . . . . .   | 64 |
| A.42 | Listening Test 2 - instructions, in english, of how to answer the first listening . . . . .  | 65 |
| A.43 | Listening Test 2 - characterization of the individual . . . . .  | 66 |
| A.44 | Listening Test 2 - example of question where the individual has to evaluate the modified sound taking into account the original audio file. Each modified sound could be equal to the original audio file, or with +25% or +50% warmth. This same type of question was done for all the audio file explained in Section 5.1. . . . . | 67 |
| A.45 | Chart of the responses for all four transformation of horn C4 . . . . .  | 68 |
| A.46 | Chart of the responses for all four transformation of clarinet C5 . . . . .  | 68 |
| A.47 | Chart of the responses for all four transformation of oboe C5 . . . . .  | 69 |
| A.48 | Chart of the responses for all four transformation of viola C5 . . . . .   | 69 |

|      |   |    |
|------|---|----|
| A.49 | Chart of the responses for all four transformation of violoncello C5 . . . . .  | 70 |
| A.50 | Variation of the value of the spectral centroid of horn C4, when increased the level of warmth by 25% and 50%, in each analysis audio file . . . . .  | 71 |
| A.51 | Variation of the value of the spectral centroid of horn C4, when decreased the level of warmth by 25% and 50%, in each analysis audio file . . . . .  | 72 |
| A.52 | Mean, median and standard deviation of the spectral centroid of horn C4, when increased the level of warmth by 25% and 50%, in each analysis audio file. The leftmost (at '0') values belong to the sound of horn C4 with no transformation. The values at '1' belongs to the sound of horn C4 with +25% warmth and the rightmost (at '2') values belong to the sound of horn C4 with +50% warmth . . . . .                 | 73 |
| A.53 | Mean, median and standard deviation of horn C4 when decreased the level of warmth by 25% and 50%. The leftmost (at '0') values belong to the sound of horn C4 with no transformation. The values at '1' belongs to the sound of horn C4 with -25% warmth and the rightmost (at '2') values belong to the sound of horn C4 with -50% warmth . . . . .  | 74 |
| A.54 | Variation of the value of warmth of horn C4, when increased the level of warmth by 25% and 50%, in each analysis audio file . . . . .   | 75 |
| A.55 | Variation of the value of warmth of horn C4, when decreased the level of warmth by 25% and 50%, in each analysis audio file . . . . .   | 75 |
| A.56 | Mean, median and standard deviation of the warmth of horn C4 when increased the level of warmth by 25% and 50%. The leftmost (at '0') values belong to the sound of horn C4 with no transformation. The values at '1' belongs to the sound of horn C4 with +25% warmth and the rightmost (at '2') values belong to the sound of horn C4 with +50% warmth . . . . .  | 76 |
| A.57 | Mean, median and standard deviation of horn C4 when decreased the level of warmth by 25% and 50%. The leftmost (at '0') values belong to the sound of horn C4 with no transformation. The values at '1' belongs to the sound of horn C4 with -25% warmth and the rightmost (at '2') values belong to the sound of horn C4 with -50% warmth . . . . .  | 77 |
| A.58 | Variation of the value of the spectral centroid of clarinet C5, when increased the level of warmth by 25% and 50%, in each analysis audio file . . . . .  | 78 |
| A.59 | Variation of the value of the spectral centroid of clarinet C5, when decreased the level of warmth by 25% and 50%, in each analysis audio file . . . . .  | 78 |
| A.60 | Mean, median and standard deviation of the spectral centroid of clarinet C5, when increased the level of warmth by 25% and 50%, in each analysis audio file. The leftmost (at '0') values belong to the sound of clarinet C5 with no transformation. The values at '1' belongs to the sound of clarinet C5 with +25% warmth and the rightmost (at '2') values belong to the sound of clarinet C5 with +50% warmth . . . . . | 79 |
| A.61 | Mean, median and standard deviation of clarinet C5 when decreased the level of warmth by 25% and 50%. The leftmost (at '0') values belong to the sound of clarinet C5 with no transformation. The values at '1' belongs to the sound of clarinet C5 with -25% warmth and the rightmost (at '2') values belong to the sound of clarinet C5 with -50% warmth . . . . .  | 80 |
| A.62 | Variation of the value of warmth of clarinet C5, when increased the level of warmth by 25% and 50%, in each analysis audio file . . . . .   | 81 |

|      |   |    |
|------|---|----|
| A.63 | Variation of the value of warmth of clarinet C5, when decreased the level of warmth by 25% and 50%, in each analysis audio file . . . . .   | 81 |
| A.64 | Mean, median and standard deviation of the warmth of clarinet C5 when increased the level of warmth by 25% and 50%. The leftmost (at '0') values belong to the sound of clarinet C5 with no transformation. The values at '1' belongs to the sound of clarinet C5 with +25% warmth and the rightmost (at '2') values belong to the sound of clarinet C5 with +50% warmth . . . . .                          | 82 |
| A.65 | Mean, median and standard deviation of clarinet C5 when decreased the level of warmth by 25% and 50%. The leftmost (at '0') values belong to the sound of clarinet C5 with no transformation. The values at '1' belongs to the sound of clarinet C5 with -25% warmth and the rightmost (at '2') values belong to the sound of clarinet C5 with -50% warmth . . . . .  | 83 |
| A.66 | Variation of the value of the spectral centroid of oboe C5, when increased the level of warmth by 25% and 50%, in each analysis audio file . . . . .  | 84 |
| A.67 | Variation of the value of the spectral centroid of oboe C5, when decreased the level of warmth by 25% and 50%, in each analysis audio file . . . . .  | 84 |
| A.68 | Mean, median and standard deviation of the spectral centroid of oboe C5, when increased the level of warmth by 25% and 50%, in each analysis audio file. The leftmost (at '0') values belong to the sound of oboe C5 with no transformation. The values at '1' belongs to the sound of oboe C5 with +25% warmth and the rightmost (at '2') values belong to the sound of oboe C5 with +50% warmth . . . . . | 85 |
| A.69 | Mean, median and standard deviation of oboe C5 when decreased the level of warmth by 25% and 50%. The leftmost (at '0') values belong to the sound of oboe C5 with no transformation. The values at '1' belongs to the sound of oboe C5 with -25% warmth and the rightmost (at '2') values belong to the sound of oboe C5 with -50% warmth . . . . .  | 86 |
| A.70 | Variation of the value of warmth of oboe C5, when increased the level of warmth by 25% and 50%, in each analysis audio file . . . . .   | 87 |
| A.71 | Variation of the value of warmth of oboe C5, when decreased the level of warmth by 25% and 50%, in each analysis audio file . . . . .   | 87 |
| A.72 | Mean, median and standard deviation of the warmth of oboe C5 when increased the level of warmth by 25% and 50%. The leftmost (at '0') values belong to the sound of oboe C5 with no transformation. The values at '1' belongs to the sound of oboe C5 with +25% warmth and the rightmost (at '2') values belong to the sound of oboe C5 with +50% warmth . . . . .  | 88 |
| A.73 | Mean, median and standard deviation of oboe C5 when decreased the level of warmth by 25% and 50%. The leftmost (at '0') values belong to the sound of oboe C5 with no transformation. The values at '1' belongs to the sound of oboe C5 with -25% warmth and the rightmost (at '2') values belong to the sound of oboe C5 with -50% warmth . . . . .  | 89 |
| A.74 | Variation of the value of the spectral centroid of viola C5, when increased the level of warmth by 25% and 50%, in each analysis audio file . . . . .   | 90 |
| A.75 | Variation of the value of the spectral centroid of viola C5, when decreased the level of warmth by 25% and 50%, in each analysis audio file . . . . .   | 90 |

|  |    |
|--|----|
| A.76 Mean, median and standard deviation of the spectral centroid of viola C5, when increased the level of warmth by 25% and 50%, in each analysis audio file. The leftmost (at '0') values belong to the sound of viola C5 with no transformation. The values at '1' belongs to the sound of viola C5 with +25% warmth and the rightmost (at '2') values belong to the sound of viola C5 with +50% warmth . . . . .                         | 91 |
| A.77 Mean, median and standard deviation of viola C5 when decreased the level of warmth by 25% and 50%. The leftmost (at '0') values belong to the sound of viola C5 with no transformation. The values at '1' belongs to the sound of viola C5 with -25% warmth and the rightmost (at '2') values belong to the sound of viola C5 with -50% warmth . . . . .  | 92 |
| A.78 Variation of the value of warmth of viola C5, when increased the level of warmth by 25% and 50%, in each analysis audio file . . . . .  | 93 |
| A.79 Variation of the value of warmth of viola C5, when decreased the level of warmth by 25% and 50%, in each analysis audio file . . . . .  | 93 |
| A.80 Mean, median and standard deviation of the warmth of viola C5 when increased the level of warmth by 25% and 50%. The leftmost (at '0') values belong to the sound of viola C5 with no transformation. The values at '1' belongs to the sound of viola C5 with +25% warmth and the rightmost (at '2') values belong to the sound of viola C5 with +50% warmth . . . . .  | 94 |
| A.81 Mean, median and standard deviation of viola C5 when decreased the level of warmth by 25% and 50%. The leftmost (at '0') values belong to the sound of viola C5 with no transformation. The values at '1' belongs to the sound of viola C5 with -25% warmth and the rightmost (at '2') values belong to the sound of viola C5 with -50% warmth . . . . .  | 95 |
| A.82 Variation of the value of the spectral centroid of violoncello C5, when increased the level of warmth by 25% and 50%, in each analysis audio file . . . . .   | 96 |
| A.83 Variation of the value of the spectral centroid of violoncello C5, when decreased the level of warmth by 25% and 50%, in each analysis audio file . . . . .   | 96 |
| A.84 Mean, median and standard deviation of the spectral centroid of violoncello C5, when increased the level of warmth by 25% and 50%, in each analysis audio file. The leftmost (at '0') values belong to the sound of violoncello C5 with no transformation. The values at '1' belongs to the sound of violoncello C5 with +25% warmth and the rightmost (at '2') values belong to the sound of violoncello C5 with +50% warmth . . . . . | 97 |
| A.85 Mean, median and standard deviation of violoncello C5 when decreased the level of warmth by 25% and 50%. The leftmost (at '0') values belong to the sound of violoncello C5 with no transformation. The values at '1' belongs to the sound of violoncello C5 with -25% warmth and the rightmost (at '2') values belong to the sound of violoncello C5 with -50% warmth . . . . .  | 98 |
| A.86 Variation of the value of warmth of violoncello C5, when increased the level of warmth by 25% and 50%, in each analysis audio file . . . . .  | 99 |
| A.87 Variation of the value of warmth of violoncello C5, when decreased the level of warmth by 25% and 50%, in each analysis audio file . . . . .  | 99 |

|      |  |     |
|------|--|-----|
| A.88 | Mean, median and standard deviation of the warmth of violoncello C5 when increased the level of warmth by 25% and 50%. The leftmost (at '0') values belong to the sound of violoncello C5 with no transformation. The values at '1' belongs to the sound of violoncello C5 with +25% warmth and the rightmost (at '2') values belong to the sound of violoncello C5 with +50% warmth . . . . . | 100 |
| A.89 | Mean, median and standard deviation of violoncello C5 when decreased the level of warmth by 25% and 50%. The leftmost (at '0') values belong to the sound of violoncello C5 with no transformation. The values at '1' belongs to the sound of violoncello C5 with -25% warmth and the rightmost (at '2') values belong to the sound of violoncello C5 with -50% warmth . . . . .               | 101 |
| A.90 | Linear regression between the weighted arithmetic mean evaluation and the spectral centroid of the sounds with increased level of warmth . . . . .   | 101 |
| A.91 | Linear regression between the weighted arithmetic mean evaluation and the spectral centroid of the sounds with decreased level of warmth . . . . .   | 102 |
| A.92 | Linear regression between the weighted arithmetic mean evaluation and the warmth of the sounds with increased level of warmth . . . . .  | 102 |
| A.93 | Linear regression between the weighted arithmetic mean evaluation and the warmth of the sounds with decreased level of warmth . . . . .  | 103 |
| A.94 | Linear regression between the warmth and the spectral centroid of all transformed sounds . . . . .   | 103 |



# List of Tables

|     |   |    |
|-----|---|----|
| 3.1 | Chosen octaves for each instruments for the first listening test . . . . .  | 16 |
| 3.2 | Results of the first listening test that aimed to evaluate how warmth in the different instrumental sounds is perceived . . . . .   | 18 |
| 3.3 | Weighted arithmetic mean, variance and standard deviation of the results of the first listening test. The present Pearson correlation values result from a correlation between the values of warmth and the weighted mean values and also from a correlation between the values of the spectral centroid and the weighted mean values. . . . .          | 19 |
| 3.4 | Values of warmth and spectral centroid of each instrumental sound. A ratio between the warmth and the spectral centroid is also calculated. The present Pearson correlation value result of correlation between the values of warmth and the values of the spectral centroid . . . . .  | 22 |
| 4.1 | Lowest Detectable Frequency according to the FFT window size, considering 44100Hz the sampling rate . . . . .   | 26 |
| 5.1 | Responses of the second listening test that aimed to evaluate the system . .  | 31 |
| 5.2 | Weighted arithmetic mean, variance and standard deviation of the results of the second listening test. The present Pearson correlation values result from a correlation between the values of warmth and the weighted mean values and also from a correlation between the values of the spectral centroid and the weighted mean values. . . . .         | 32 |
| 5.3 | Calculation of the Warmth and Spectral Centroid of each instrumental sounds that were modified according to a certain degree of warmth. It was also calculated the ratio between warmth and the centroid. The present Pearson correlation value result of the correlation between the values of warmth and the values of the spectral centroid. . . . . | 33 |



# Abbreviations and symbols

|      |   |
|------|---|
| ADC  | Analog-to-Digital-Conversion                              |
| DAC  | Digital-to-Analog-Conversion                              |
| DSP  | Digital Signal Processing                                 |
| FFT  | Fast Fourier Transform                                    |
| Hz   | Hertz - The unit of frequency of the International System |
| MIR  | Music Information Retrieval                               |
| PCM  | Pulse-Code Modulation                                     |
| RM   | Remainder Magnitude                                       |
| STFT | Short-time Fourier Transform                              |
| WR   | Warmth Region   |



# Chapter 1

## Introduction

### 1.1 Context

Today, audio processing enables composers and musicians to freely manipulate the characteristics of sound.

Traditionally, music experts refer to sound warmth according to two levels of granularity. The first one is rather broad and categorizes the timbre of different musical instruments from ‘cold’ to ‘warm’. For example, the low register of the clarinet tends to have a much warmer sound than the piccolo. Similarly, the horn has a much warmer sound than the trumpet. The second exists at a smaller scale and consists on the manipulations that expert musicians perform, shaping their instrument timbre according to different shades of warmth (e.g. in manipulating the point at which the bow hits the strings, a violinist can change drastically the sound warmth of the instrument - these techniques are referred to as *sul tasto* and *sul ponticello*). Music performers, composers and audio engineers have been wanting to manipulate qualities of timbre[2]. However, the last two decades marked a new scientific era in sound processing, having developed descriptors to extract attribute from the sound spectrum[3].

Music information retrieval(MIR)[4] is a growing field of research concerned with the extraction and inference of meaningful features from music (from the audio signal, symbolic representation), indexing of music using these features, and the development of different search and retrieval systems (for instance, content-based search, music recommendation systems, or user interfaces for browsing large music collections), as explained by Downie[5].

### 1.2 Motivation

Up to this day, the term warmth falls in a category of music audio attributes, such as bright, dull, flat, which expert musicians and music producers widely adopted to address timbral attributes of sound. This musical jargon is highly relevant to the community of musical experts.

Being still hard to define mathematically, creates an opportunity to further investigate and try to define an algorithm, a system, which would enable us to manipulate this subjective attribute of sound using digital signal processing techniques.

To a lesser extent, this dissertation aims to contribute to music perception by answering questions such as “Is this sound warm? How is warmth perceived? What is warmth?”. By the end of the dissertation it is hoped to get some clarifications on the matter.

### 1.3 Goals

The purpose of this dissertation is to expand upon previously published results and create a software to manipulate the warmth of sound that could be used worldwide in music production, in audio effects, music composition in general.

Towards this goal, we will start by reviewing the existing proposal of Williams et.al[1] and Antoine[6] and understand how the concept of warmth is perceived.

After this study, we design a listening test where the participants evaluate the level of warmth in several monophonic instrumental sounds.

Then, we develop, in a controlled environment, a descriptor based on additive synthesis. Accordingly, the definition of the descriptor will be redefined mainly regarding the output.

Ultimately, we generate a second listening test in order to evaluate the descriptor.

### 1.4 Document Structure

In Chapter 2 we review the state of the art of digital audio processing, introducing an overview of digital audio processing, music information and content-based description of musical audio signals. Later we review the existing work on warmth description in musical audio.

In Chapter 3 we present a perceptual evaluation of sound warmth, and results, which aims to evaluate how people perceive sound warmth.

In Chapter 4 we propose a system for manipulating the warmth in an audio file. We start by presenting an overview of our system, followed by a detailed explanation of its implementation.

In Chapter 5 we present the evaluation of our system. We detail and analyze the results of the listening test designed to evaluate the sounds that were transformed according to different levels of warmth.

In Chapter 6 we present conclusion of this work and point direction for future work.

## Chapter 2

# Overview of Digital Audio Processing

In this chapter, we start with an overview of techniques and applications of Digital Signal Processing (DSP). After, we introduce the field of Music Information Retrieval, and its relevant techniques used to extract features from audio signals. Next, we present and detail the different levels of abstraction of audio description. The chapter concludes with the taxonomy of low-level layer of audio descriptors.

### 2.1 Digital Signal Processing

Digital Signal Processing[7] is the process of analysis and manipulation - applying mathematical and computational algorithms - of data from analog signals (such as sound, light or heat) that have been digitized or digitally generated signals. This includes a wide variety of technical tools such as: filtering; speech recognition; image enhancement; data compression; neural networks and more.

The use of DSP started around the '70s, when digital computers first appeared and became one of the most powerful technologies that would shape science and engineering in the XX<sup>th</sup> century, across a large range of applications[8]:

- Communication Systems - modulation/demodulation, channel equalization, echo cancellation;
- Consumer electronics - perceptual coding of audio and video on DVDs, speech synthesis, speech recognition;
- Music - synthesized instruments, audio effects, noise cancellation;
- Medical Diagnostics - magnetic resonance and ultrasonic, imaging, computed tomography, electroencephalography (EEG), electrocardiography (ECG), magnetoencephalography (MEG), automatic external defibrillator (AED), audiology;

- Geophysics - seismology, oil exploration;
- Astronomy - Very-long-baseline interferometry (VLBI), speckle interferometry;
- Experimental Physics - sensor-data evaluation;
- Aviation - radar, radio navigation;
- Security - steganography, digital watermarking, biometric identification, surveillance systems, signals intelligence, electronic warfare;

Sound and light are good examples of analog signals, which machines cannot compute. Therefore, a system is needed to convert analog signals to digital signals - a microphone regarding sound, and a digital camera if the signal is light.

In Figure 2.1 we show an example of analog and digital processing of sound. In analog processing the ear captures the sound waves and send them to the brain to process. In digital processing, the sound is captured by the microphone which is then converted from analog to digital and sent to an electronic device to be processed.

The Analog-to-Digital conversion system (ADC) performs the sampling of the signal's amplitude at a sampling rate,  $F_s$ , followed by a quantization process, which converts to a Pulse-Code modulation (PCM). In Figure 2.2 we can see the process of converting an analog signal to digital format represented in a sequence of 0's and 1's that machines can understand . When the signal is in digital format we are able to analyze, process and manipulate the signal.

To reconvert the signal from digital to analog it is used an Digital-to-Analog conversion (DAC) system that can convert the digital output signal to an analog output signal.

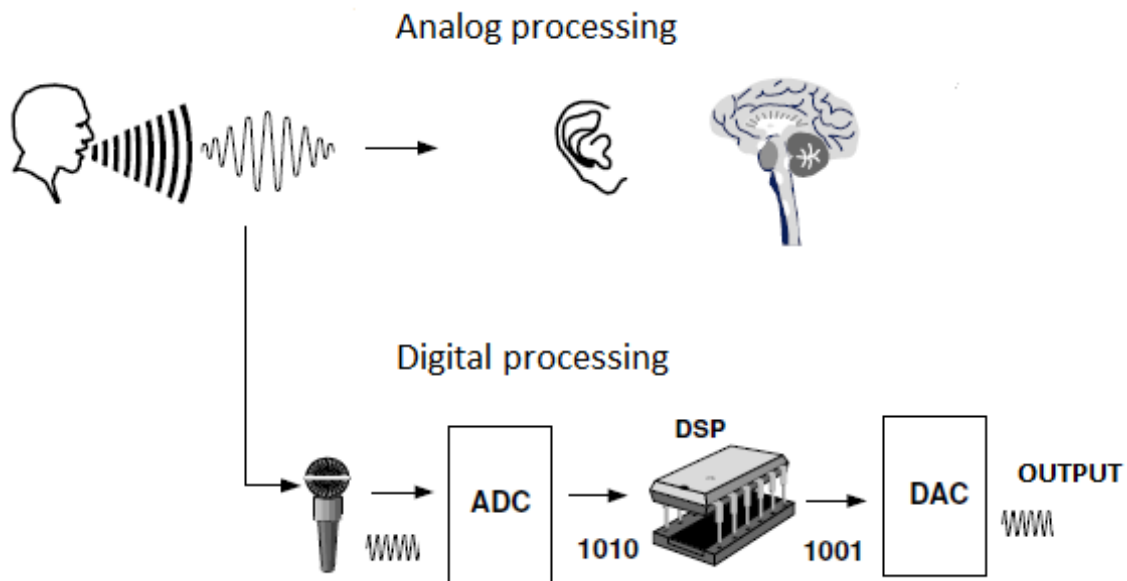

Figure 2.1: Digital Audio Processing [9]

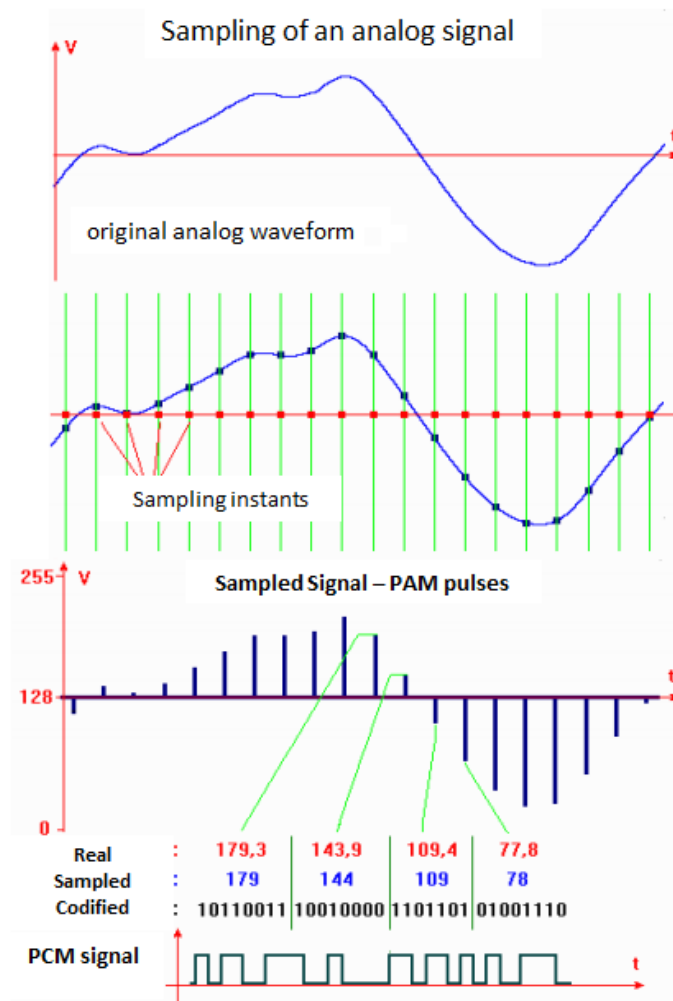

Figure 2.2: Analog-to-Digital Conversion [10]

## 2.2 Music Information Retrieval

At a time where technology tends towards ubiquitous computing, music is mainly accessed in digital format. We used to listen to music using the Walkman, Discman or even in a stereo system at home. Today music streaming is the trend, and there are a number of known services like Spotify<sup>1</sup>, Pandora<sup>2</sup> and Deezer<sup>3</sup> that have an enormous database from where the user can choose what to listen.

But this vast amount of digital audio available requires a deeper understanding of how to process audio signals, in particular how retrieving algorithms are formulated, to be able to extract information from the audio file to enhance user centered retrieval methods from these large archives.

<sup>1</sup><https://www.spotify.com/>

<sup>2</sup><https://www.pandora.com/>

<sup>3</sup><https://www.deezer.com/>

The field of research in MIR[11] gathers people with background on computer science and information retrieval, musicology and music theory, audio engineering and digital signal processing, machine learning and psychology, working together to create and enhance toolboxes to better describe and extract relevant information from audio data[12].

MIR has several application domains[4] such as music retrieval, music recommendation, music playlist generation and music browsing interfaces. All these applications demand methods for retrieving information, for example *audio identification* or *fingerprinting*, where the goal is to retrieve or identify the same fragment of a given music recording with some robustness requirements. Another is *query by humming* and *query by tapping*, where the goal is to retrieve music from a given melodic or rhythmic input (in audio or symbolic format) which is described in terms of features and is compared to the documents in a music collection (i.e Shazam<sup>4</sup>)[13].

## 2.3 Content-based audio description

A lot of MIR research is based on human perception since the top-level ground-truth data mostly consists of human annotations[14]. The description of audio can be presented in an hierarchical structure, as shown by Herrera[15], from low-level to perceptual features (mid-level) and finally to a semantic description (high-level).

Descriptors are resources of digital audio processing that, from the temporal and spectral variation of the frequencies, represent the characteristics of the signal, which are useful for the creation of a taxonomy of the properties of the signal content.

### 2.3.1 Low-Level Descriptors

The literature in signal processing and speech processing documents a large amount of low-level audio features, either in the time domain (e.g. amplitude, zero-crossing rate, and autocorrelation coefficients) or in the frequency domain (e.g. spectral centroid, spectral skewness, and spectral flatness)[17]. They are computed from the digitized audio data by simple means and with very little computational effort in a straight or derivative fashion.

Most low-level descriptors make little sense to humans, especially if one does not master statistical analysis and signal processing techniques, because the terminology used to designate them denotes the mathematical operations on the signal representation.

### 2.3.2 Mid-Level Descriptors

As stated by Gutiérrez[18], mid-level descriptors are used when it is necessary to carry-out operations which allow, after an analysis of the audio signal, to perform some generalization. This generalization can be a description of the data according to music theory, such as pitch, keys, meter, onsets, beats, harmonic complexity.

---

<sup>4</sup><https://www.shazam.com/>

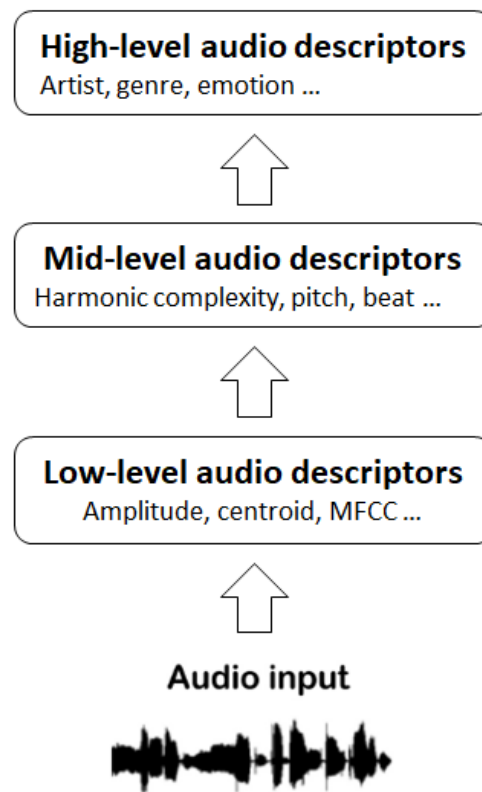

Figure 2.3: Layers of audio analysis based on[16]

A downside of this descriptor group is the time-consuming learning phase that most of the algorithms require[19].

### 2.3.3 High-Level Descriptors

High-level descriptors, also referred to as user-centered descriptors, express some categorical, subjective, or semantic attributes of the sound, such as mood and genre[20].

The computation of high-level descriptors involves some level of learning that is commonly carried from user data (as is the case of mid-level descriptors). As an example, let us imagine a simplistic “mood” descriptor consisting of labels “happy” and “sad.” In order to automatically annotate unknown audio sources with such labels, it is necessary to initially create a computational model that distinguishes the two classes - happy and sad - by commonly relying on human annotations of audio tracks and machine learning algorithms; and then, one would be ready to compare a new track against the created model to infer its mood[19].

### 2.3.4 From Low-Level to Mid-Level to High-Level Descriptors

The jump from low- or mid-level descriptors to high-level descriptors requires bridging a semantic gap[15].

Audio descriptors are used in audio processing, to identify and manipulate sound characteristics that are perceived and qualified by the human ear. They are an essential instrument in MIR research that seek to systematize and model the qualitative sounds perception. The low-level audio descriptors are the basic components to analyze the sound as described in Figure 2.4, created by Geoffrey Peeters.

For a better understanding, let's use gastronomy as an analogy where the sound is represented by the dish. We can say that low-level descriptors are proteins, lipids, carbohydrates. Mid-level descriptors represent the ingredients that make up the dish, like fish or meat, vegetable or spices. High-level descriptors correspond to the attributes used to identify the dish - if it is indian, mexican, chinese, japanese or italian - or if the dish is spicy, sour, bitter or blend.

Up next, we can see an approach to “recipes” of the attributes of the timbre related to subjective perception of sound, such as:

**Brightness** is related to the spectral centroid[21]. The higher the spectral centroid, the brighter the sound.

**Dullness** is also related to the spectral centroid[22]. A low spectral centroid value indicates that the sound is dull.

**Roughness** is related to the interaction between partials within the critical bandwidth and also the energy above the 6<sup>th</sup> harmonic[23].

**Breathiness** It has been defined that *breathiness* is described comparing the fundamental amplitude against noise content and the spectral slope[24]. The bigger the ratio between fundamental amplitude and the noise content, the breathier the sound.

## 2.4 Taxonomy of low-level audio descriptors

A system for the extraction of audio descriptors is usually organized according to the taxonomy of the descriptors. We can distinguish three main properties of an audio descriptor[25]: temporal energy envelope, spectrum shape and sinusoidal harmonic partials, or just harmonic. The temporal energy envelope can be defined as a global descriptor and the autocorrelation coefficients, zero-crossing rate, spectrum shape and the harmonic defined as time-varying descriptors.

### 2.4.1 Temporal Energy Envelope

The temporal energy envelope can be illustrated by several descriptors, such as: attack, decay, sustain, log-attack time, temporal centroid, frequency and amplitude. These are used to know the sound's characteristics and behavior along the domain of time.

Below is presented an example of a temporal descriptor[25]:

|                              | Audio descriptor                  | Units           | Abbreviation | Input representation   |
|------------------------------|-----------------------------------|-----------------|--------------|--|
| Global descriptors           | Attack                            | s               | Att          | Temporal Energy Envelope   |
|                              | Decay                             | s               | Dec          |  |
|                              | Release                           | s               | Rel          |  |
|                              | Log-Attack Time                   | log(s)          | LAT          |  |
|                              | Attack Slope                      | a/s             | AttSlope     |  |
|                              | Decrease Slope                    | log(a)/s        | DecSlope     |  |
|                              | Temporal Centroid                 | s               | TempCent     |  |
|                              | Effective Duration                | s               | EffDur       |  |
|                              | Amplitude of Energy Modulation    | a               | AmpMod       |  |
| Time-varying descriptors     | Autocorrelation (12 coefficients) | -               | AutoCorr     | Audio Signal   |
|                              | Zero Crossing Rate                | s <sup>-1</sup> | ZcrRate      |  |
|                              | RMS-Energy Envelope               | a               | RMSEnv       | Temporal Energy Envelope   |
|                              | Spectral Centroid                 | F               | SpecCent     | STFTmagnitude (STFTmag)<br>STFTpower (STFTpow)<br>ERBfft (ERBfft)<br>ERBgammatone (ERBgam)<br>Harmonic |
|                              | Spectral Spread                   | F               | SpecSpread   |  |
|                              | Spectral Skewness                 | -               | SpecSkew     |  |
|                              | Spectral Kurtosis                 | -               | SpecKurt     |  |
|                              | Spectral Slope                    | F <sup>-1</sup> | SpecSlope    |  |
|                              | Spectral Decrease                 | -               | SpecDecr     |  |
|                              | Spectral Rolloff                  | F               | SpecRollOff  |  |
|                              | Spectro-temporal variation        | -               | SpecVar      |  |
|                              | Frame Energy                      | I               | FrameErg     |  |
|                              | Spectral Flatness                 | -               | SpecFlat     | STFTmag, STFTpow, ERBfft, ERBgam   |
|                              | Spectral Crest                    | -               | SpecCrest    |  |
|                              | Harmonic Energy                   | a <sup>2</sup>  | HarmErg      | Harmonic   |
|                              | Noise Energy                      | a <sup>2</sup>  | NoiseErg     |  |
|                              | Noisiness                         | -               | Noisiness    |  |
|                              | Fundamental Frequency             | Hz              | F0           |  |
|                              | Inharmonicity                     | -               | InHarm       |  |
| Tristimulus (3 coefficients) | -                                 | TriStim         |              |  |
| Harmonic Spectral Deviation  | a                                 | HarmDev         |              |  |
| Odd to even harmonic ratio   | -                                 | OddEveRatio     |              |  |

Figure 2.4: Table of descriptor by G. Peeters [25]

- Temporal Centroid (TC) - is the temporal center of gravity of the energy envelope. It is used to analyze percussive sounds.[25]

$$TC = \frac{\sum_{n=n1}^{n2} t_n \cdot e_n}{\sum_n e_n} \quad (2.1)$$

Where:  $n1$  and  $n2$  are the first and last values of  $n$ , respectively, so that  $e_n$  is above 15% of its maximum value.

### 2.4.2 Spectral Features

The spectrum shape can be described by several descriptors, such as: autocorrelation, zero crossing rate, spectral centroid, spectral kurtosis, spectral skewness, spectral spread and frame energy. The spectral descriptors extracted are the following [26] [25]:

- **Spectral Centroid** corresponds to the spectral center of gravity of the spectrum and is known to be connected to the perceptual feature *brightness*:

$$SC = \frac{\sum_{k=1}^K f_k \cdot a_k}{\sum_{k=1}^K a_k} \quad (2.2)$$

$$f_k = i \cdot \frac{\text{samplerate}}{\text{FFTwindowSize}}$$

Where:

$K$ , is half of the FFT window size;

$k$ , is the bin index;

$a_k$ , is the magnitude of the bin  $k$

$f_k$ , is the frequency of the bin  $k$ , in Hertz.

- **Spectral Spread** (SS), also known as spectral standard-deviation, measures the variance of the spectral centroid:

$$SS = \sqrt{\sum_{k=1}^K (f_k - SC)^2 \cdot p_k} \quad (2.3)$$

$$p_k = \frac{a_k}{\sum_{k=1}^K a_k}$$

Where  $p_k$  represents the normalized value of the magnitude of the Short-time Fourier Transform (STFT).

- **Spectral Skewness** gives a measure of the asymmetry of the spectrum around its center of gravity:

$$SSk = \frac{\sum_{k=1}^K (f_k - SC)^3 \cdot p_k}{SS^3} \quad (2.4)$$

- **Spectral Kurtosis** (SK) allows a measure of spectrum flatness around its centroid:

$$SK = \frac{\sum_{k=1}^K (f_k - SC)^4 \cdot p_k}{SS^4} \quad (2.5)$$

where  $p_k$  is the normalized energy envelope.

- **Spectral Slope**

$$slope = \frac{n \sum_{k=1}^K f_k \cdot a_k - \left( \sum_{k=1}^K f_k \cdot \sum_{k=1}^K a_k \right)}{\sum_{k=1}^K a_k \cdot \left( K \sum_{k=1}^K f_k^2 - \left( \sum_{k=1}^K f_k \right)^2 \right)} \quad (2.6)$$

- **Spectral Decrease** (SD) represents the magnitude decrease of the spectrum. It was proposed by Krimphoff[27] in his perceptual studies:

$$SD = \frac{\sum_{k=2}^K \frac{a_k - a_1}{k - 1}}{\sum_{k=2}^K a_k} \quad (2.7)$$

- **Spectral Roll-off** (SR) is defined as the frequency  $f_c$  below which 95% of the signal energy is contained. This feature was proposed by Sheirer et.al[28], where  $x$  represents the roll-off point:

$$SR = \sum_{f=0}^{f_c} a_f^2 = x \cdot \sum_{f=0}^{F_n} a_f^2 \quad (2.8)$$

Where  $F_n$  is the Nyquist frequency.

### 2.4.3 Sinusoidal Harmonic Partial

The harmonic can be described by a group of descriptors, such as: harmonic energy, noise energy, noisiness, fundamental frequency, tristimulus and harmonic spectral deviation[25].

- **Harmonic energy** is the energy of the signal corresponding to the harmonic partial:

$$E_H = \sum_{h=1}^H a_h^2 \quad (2.9)$$

- **Noise energy** is the energy of signal not containing the harmonic partials:

$$\begin{aligned} E_N &= E_T - E_H \\ E_T &= \sum_i a_i^2 \end{aligned} \quad (2.10)$$

- **Noisiness** is the ratio of the noise energy to the total energy:

$$noisiness = \frac{E_N}{E_T} \quad (2.11)$$

- **Tristimulus** was first introduced by Pollard et.al[29] as a timbral equivalent to color attribute in vision. It consists of three different energy ratios, allowing a good description of the first harmonics of the spectrum:

$$\begin{aligned}
 T1 &= \frac{a_1}{\sum_{h=1}^H a_h} \\
 T2 &= \frac{a_2 + a_3 + a_4}{\sum_{h=1}^H a_h} \\
 T3 &= \frac{\sum_{h=5}^H a_h}{\sum_{h=1}^H a_h}
 \end{aligned} \tag{2.12}$$

Both the spectrum shape and the sinusoidal harmonic partial are used to analyze the audio along the frequency domain.

## 2.5 Description of Sound Warmth

### 2.5.1 Williams and Brookes' Metric

The study of the warmth of a sound came following their previous studies on brightness and softness[30][31][1]. In their research, they selected warmth as the third timbral attribute because it has a certain degree of acoustic overlap with the perceptual feature brightness[32]. It has been shown that warmth has a correlation with spectral slope, spectral centroid and a relation between the energy of the first three harmonics and the remainder of the signal[33].

During the development of the hybrid timbre morpher[1], Williams and Brookes first extracts and interpolates the warmth, followed by a compensation of the acoustic overlap between all three perceptual features (brightness, softness and warmth). In Figure 2.5 we show a block diagram as an overview of their study.

#### 2.5.1.1 Warmth Region

The warmth region is the area contemplating the energy between the signal's fundamental up to 3.5 times this frequency. When in the presence of a harmonic signal this area would encompass the first three harmonics. In the case of a signal containing inharmonic partials and/or noise component, the energy in this area is intended to perform a similar timbral role to that of the first three harmonics.

$$\text{WarmthRegion} = \frac{WR}{RM} \tag{2.13}$$

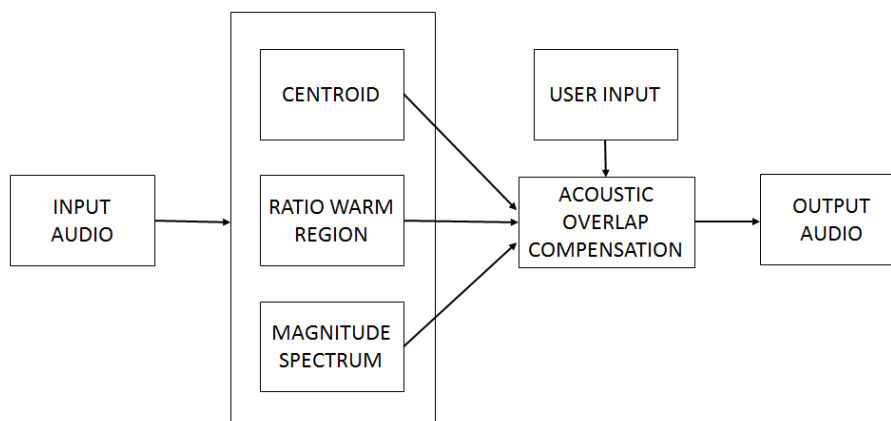

Figure 2.5: Architecture of Williams and Brookes' sound warmth descriptor

$$WR = \sum_{f=1}^{3.5} a_f \quad (2.14)$$

$$\begin{aligned}
 RM &= FM - WR \\
 &= \sum_f a_f, \text{ where } f \in \mathbb{R}_0^+ \setminus [1 \ 3.5]
 \end{aligned} \quad (2.15)$$

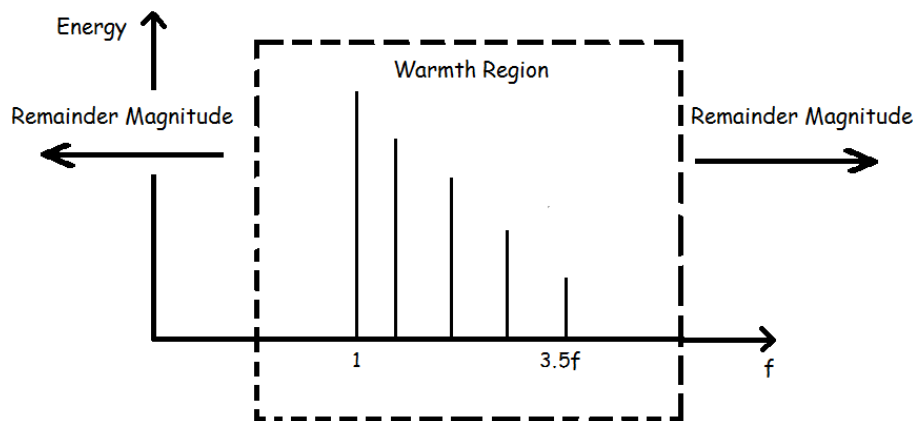

Figure 2.6: Definition of the Warmth Region

### 2.5.2 Aurélian's Metric

Aurélian followed the study of William and Brookes[1] by adding a listening test using samples of several instruments in terms of timbral characteristics such as brightness, breathiness, roughness, dullness and warmth[6].

The results for the first four perceptual features showed strong correlation between the participant's responses and the classification system ratings[6]. However, the same cannot be said for warmth, as the results felt short and inconclusive.

Given the lack of results and more in-depth information regarding his approach for the analysis of warmth in sound, we designed an experiment which aims at evaluating the perceptual basis of the attributes considered in both metrics, which we detail at length in the following Chapter.

## Chapter 3

# Accessing the perceptual manifestation of sound warmth

Previously, we reviewed the metrics that have been proposed in related literature to gauge the warmth of a sound. Given the limitations, we compare the perception of warmth in sound with the existing metrics, we conducted an online listening experiment of a set of instrumental sounds.

This chapter details an experiment design followed by exposure of the results and ends with the analysis of the instrumental sounds. In other words, we present and comment on the values of warmth and spectral centroid of the instrumental sounds used on the listening test.

### 3.1 Perceptual Evaluation

#### 3.1.1 Listening Test

In order to design this listening test<sup>1</sup>, we used the IRCAM's SOL database of acoustic instruments. In this database we can find audio samples from almost all families of instruments (with the exception of percussion) which cover a wide spectral range, roughly from the lowest octave (e.g A1<sup>23</sup>) to the highest octave (e.g A8).

Due to the vast number of samples, with their unique timbral richness, and taking into account the extension of the listening test<sup>[34]</sup>, we created a data set consisting of 18 acoustic instrumental sounds - two instruments for each family of instruments and three octaves for each instrument - with variable duration, ranging from 2 to 8 seconds. The criteria for selecting these samples was that all instruments had to have the central C (Do)

---

<sup>1</sup>The listening test is available at <http://npires91.poll daddy.com/s/listening-test-1>

<sup>2</sup>Music notation using the alphabet to represent musical notes, from A (La) to G(Sol)

<sup>3</sup>Music notation, using numbers, to represent the octave of the musical note (commonly present in a piano keyboard), where 1 represents 1st (lowest) octave and 8 represents the 8th (highest) octave

sound as a common audio sample, which can be seen in Table 3.1. The test can be found in Appendix A.2.

Participants were asked to rate on a 7-point Likert scale (1-7) the level of warmth of the instrumental sounds, where 1 corresponds to not warm at all and 7 to completely warm. They were asked to listen - using high quality headphones - to the entire duration of the sound before rating it. To prevent response bias introduced by order effects, the musical examples were presented in a random order. To submit their ratings and complete the listening test, the participants were asked to rate all sound examples.

| Instruments \ Octaves | C1 | C2 | C3 | C4 | C5 | C6 | C7 |
|-----------------------|----|----|----|----|----|----|----|
| Tuba                  |    | X  | X  | X  |    |    |    |
| Horn                  |    | X  | X  | X  |    |    |    |
| Clarinet              |    |    |    | X  | X  | X  |    |
| Oboe                  |    |    |    | X  | X  | X  |    |
| Viola                 |    |    | X  | X  | X  |    |    |
| Violoncello           |    |    | X  | X  | X  |    |    |

Table 3.1: Chosen octaves for each instruments for the first listening test

### 3.1.2 Results

The size of the perceptual study sample was of 128 individuals, with the following profiles:

- Age - from 17 to 45 years old
- Gender - 67% male and 33% female
- Musical proficiency - 13% with high expertise in music production, creation and performance; 45% with some expertise and 42% with no expertise;

To examine the results of the listening test we show the number of responses per musical example for each level of warmth.

Figure 3.1 shows the results using color system, in column “Octave” the gradient from turquoise to dark orange, where the first represents a higher and colder pitch and the latter represents a lower and warmer pitch. We also highlight the responses, for each audio sample, where dark brown represents the level of warmth with most responses and light brown with level of warmth with second most responses. The same results can be seen in Table 3.2.

Taking a closer look at the results for the tuba and horn, we can see that the responses concentrated in the same level of warmth, as the majority answered “*Moderately warm*” for the distinct sounds.

| Instruments   | Octave | Warmth | Centroid | Ratio between warmth and centroid | 1  | 2                  | 3             | 4               | 5         | 6              | 7               |
|---------------|--------|--------|----------|-----------------------------------|--|--------------------|---------------|-----------------|-----------|----------------|-----------------|
|               |        |        |          |                                   | Not warm at all                                      | Very slightly warm | Slightly warm | Moderately warm | Very Warm | Extremely Warm | Completely Warm |
| Tuba          | C2     | 0.29   | 382.23   | 0.075%                            | 4  | 13                 | 17            | 30              | 24        | 23             | 17              |
|               | C3     | 3.83   | 345.29   | 1.108%                            | 6  | 12                 | 12            | 33              | 34        | 22             | 9               |
|               | C4     | 66.95  | 347.95   | 19.241%                           | 7  | 12                 | 25            | 44              | 19        | 16             | 5               |
| Horn          | C2     | 0.22   | 484.42   | 0.045%                            | 0  | 10                 | 16            | 28              | 25        | 21             | 14              |
|               | C3     | 1.70   | 582.37   | 0.292%                            | 7  | 11                 | 28            | 35              | 20        | 7              | 2               |
|               | C4     | 4.54   | 619.72   | 0.733%                            | 3  | 15                 | 16            | 28              | 21        | 19             | 8               |
| Clarinet      | C4     | 1.34   | 1,095.70 | 0.122%                            | 4  | 19                 | 31            | 38              | 19        | 15             | 2               |
|               | C5     | 2.62   | 1,717.00 | 0.153%                            | 15   | 42                 | 27            | 29              | 11        | 2              | 2               |
|               | C6     | 23.00  | 1,981.50 | 1.161%                            | 66   | 34                 | 13            | 7               | 5         | 2              | 1               |
| Oboe          | C4     | 0.13   | 1,682.70 | 0.008%                            | 17   | 37                 | 35            | 31              | 7         | 1              | 0               |
|               | C5     | 1.79   | 2,034.00 | 0.088%                            | 38   | 52                 | 21            | 12              | 4         | 1              | 0               |
|               | C6     | 2.34   | 1,219.50 | 0.192%                            | 74   | 32                 | 9             | 7               | 4         | 0              | 2               |
| Viola         | C3     | 0.39   | 1,712.90 | 0.023%                            | 6  | 16                 | 26            | 41              | 26        | 11             | 2               |
|               | C4     | 0.37   | 1,757.70 | 0.021%                            | 9  | 21                 | 40            | 39              | 21        | 2              | 1               |
|               | C5     | 0.35   | 2,226.30 | 0.016%                            | 18   | 39                 | 26            | 28              | 12        | 4              | 1               |
| Cello         | C3     | 0.87   | 1,219.50 | 0.071%                            | 3  | 7                  | 16            | 31              | 42        | 16             | 13              |
|               | C4     | 0.31   | 1,684.00 | 0.019%                            | 4  | 20                 | 32            | 37              | 21        | 10             | 4               |
|               | C5     | 1.07   | 2,354.80 | 0.046%                            | 13   | 48                 | 24            | 25              | 13        | 2              | 3               |
| Octave Legend |        |        |          |                                   | Most warm <span style="float:right">Less warm</span> |                    |               |                 |           |                |                 |

Figure 3.1: Responses of the first listening test with a graphical color code representation

On the other hand, the string family instruments (viola and violoncello) were evaluated as expected as we can see a step-like distribution in their responses. For lower octaves, they were evaluated with a higher level of warmth.

In the responses for the clarinet we can see a step-like distribution, similar to the strings family responses. For the oboe, the results of the sounds example C5 and C6 were evaluated as expected, but for the C4 participants were divided which resulted in evaluation both slightly, very slightly and moderately warm.

In order to know which sound was evaluated as the warmest, and least warm, we calculated the weighted arithmetic mean of the results, where each evaluation had a weight from 1 to 7 (the same as the Likert scale). After examining Table 3.3 we conclude that the sound of the violoncello C3 was the warmest sound and, on the other hand, the sound of the oboe C6 was the least warm of the data set.

## 3.2 Analysis of the instrumental sounds

For the purpose of knowing if there is a correlation between the warmth and spectral centroid of the musical examples and the results from the listening test, we created a pure data patch (Figure A.2 and A.1) that calculates the warmth and spectral centroid of each analysis window for each instrumental sound. It also calculates the mean and standard deviation of the values of warmth and spectral centroid and also a ratio between warmth and the centroid, which are presented in Table 3.4. All the results were gathered and analyzed using a Matlab script.

|             | Range  | 1        | 2                  | 3             | 4               | 5         | 6              | 7               |
|-------------|--------|----------|--------------------|---------------|-----------------|-----------|----------------|-----------------|
| Instruments | Octave | Not warm | Very slightly warm | Slightly warm | Moderately warm | Very warm | Extremely warm | Completely warm |
| Tuba        | C2     | 4        | 13                 | 17            | 30              | 24        | 23             | 17              |
|             | C3     | 6        | 12                 | 12            | 33              | 34        | 22             | 9               |
|             | C4     | 7        | 12                 | 25            | 44              | 19        | 16             | 5               |
| Horn        | C2     | 0        | 10                 | 16            | 28              | 25        | 21             | 14              |
|             | C3     | 7        | 11                 | 28            | 35              | 20        | 7              | 2               |
|             | C4     | 3        | 15                 | 16            | 28              | 21        | 19             | 8               |
| Clarinet    | C4     | 4        | 19                 | 31            | 38              | 19        | 15             | 2               |
|             | C5     | 15       | 42                 | 27            | 29              | 11        | 2              | 2               |
|             | C6     | 66       | 34                 | 13            | 7               | 5         | 2              | 1               |
| Oboe        | C4     | 17       | 37                 | 35            | 31              | 7         | 1              | 0               |
|             | C5     | 38       | 52                 | 21            | 12              | 4         | 1              | 0               |
|             | C6     | 74       | 32                 | 9             | 7               | 4         | 0              | 2               |
| Viola       | C3     | 6        | 16                 | 26            | 41              | 26        | 11             | 2               |
|             | C4     | 9        | 21                 | 40            | 39              | 21        | 2              | 1               |
|             | C5     | 18       | 39                 | 26            | 28              | 12        | 4              | 1               |
| Cello       | C3     | 3        | 7                  | 16            | 31              | 42        | 16             | 13              |
|             | C4     | 4        | 20                 | 32            | 37              | 21        | 10             | 4               |
|             | C5     | 13       | 48                 | 24            | 25              | 13        | 2              | 3               |

Table 3.2: Results of the first listening test that aimed to evaluate how warmth in the different instrumental sounds is perceived

Since the sound of violoncello C3 and oboe C6 were evaluated as the most and least warm sounds, respectively, in Figure 3.2 and 3.3 we compare the variation of the spectral centroid and warmth, in each analysis window, for both instruments. We can see that oboe C6 has a much higher spectral centroid than violoncello C3. The amplitude of the signal on the warmth region is much lower on violoncello C3 than the oboe C6 which resulted in violoncello C3 being evaluated as the warmest sound and oboe C6 as the least warm sound of the data set.

Despite the differences on the variation of the spectral centroid, due to the physical but also timbral characteristics of each instrument, the values vary in the same way, that is, the spectral centroid varies proportionally to the musical note. In other words, the higher the note higher the centroid. This can be seen in Appendix A.3.

There is only one instrument that is an exception, which corresponds to the tuba. When analyzing the sounds of the tuba, we detected an unexpected variation of the spectral centroid and warmth. The variations of the spectral centroid don't follow what was mentioned earlier, since the tuba's centroid is not varying proportionally to the pitch. We expected, between the three tuba sounds, that the values of the spectral centroid of tuba C2 were the lowest and the values of the spectral centroid of C4 would be the highest, however this does not happen as the values of the spectral centroid of tuba C2 are high-

| Instruments                                     | Octave | Weighted Arithmetic Mean      | Variance | Std  |
|---|--------|-------------------------------|----------|------|
| Tuba  | C2     | 4.52                          | 2.66     | 1.63 |
|   | C3     | 4.4                           | 2.32     | 1.52 |
|   | C4     | 3.97                          | 2.06     | 1.44 |
| Horn  | C2     | 4.13                          | 2.14     | 1.46 |
|   | C3     | 3.2                           | 1.74     | 1.32 |
|   | C4     | 3.66                          | 2.38     | 1.54 |
| Clarinet  | C4     | 3.8                           | 1.83     | 1.35 |
|   | C5     | 2.95                          | 1.75     | 1.32 |
|   | C6     | 1.91                          | 1.63     | 1.27 |
| Oboe  | C4     | 2.82                          | 1.32     | 1.15 |
|   | C5     | 2.18                          | 1.21     | 1.1  |
|   | C6     | <b>1.77</b>                   | 1.49     | 1.22 |
| Viola   | C3     | 3.83                          | 1.78     | 1.34 |
|   | C4     | 3.52                          | 1.53     | 1.24 |
|   | C5     | 2.95                          | 1.86     | 1.37 |
| Cello   | C3     | <b>4.58</b>                   | 1.96     | 1.4  |
|   | C4     | 3.76                          | 1.86     | 1.36 |
|   | C5     | 2.96                          | 1.9      | 1.38 |
| Warmth Pearson correlation ( $r_s$ )            |        | 0.022<br>p-value = 0.933457   |          |      |
| Spectral Centroid Pearson correlation ( $r_s$ ) |        | -0.598<br>p-values = 0.009955 |          |      |

Table 3.3: Weighted arithmetic mean, variance and standard deviation of the results of the first listening test. The present Pearson correlation values result from a correlation between the values of warmth and the weighted mean values and also from a correlation between the values of the spectral centroid and the weighted mean values.

est. This can be seen in Figure A.19. This might be due to a corruption in the audio files, which was only detected when performing a spectral analysis but didn't affect the perceptual evaluation. For this reason, all sounds of the tuba won't be, in the future, submitted to transformation by our system.

As we can observe from the values in Table 3.3, the spectral centroid and the weighted mean of the evaluation present a high Pearson correlation of -0.59, albeit the warmth shows a not so satisfying Pearson correlation of 0.022. Furthermore, by looking at Figure 3.4 we can verify that the spectral centroid correlates with the listeners' responses because as said earlier, the spectral centroid varies proportionally with the weighted mean values. The sounds evaluated as warmer have a lower centroid, and the sounds evaluated as colder (less warm) have a higher centroid. Taking a look at Figure 3.5 we can't correlate the warmth with the listeners' evaluation.

In Figure 3.6 we have a linear regression between the sounds' warmth and their spectral centroid. Most of the results are dispersed, leading us to the conclusion that there is no clear correlation between warmth and the spectral centroid. This conclusion is supported

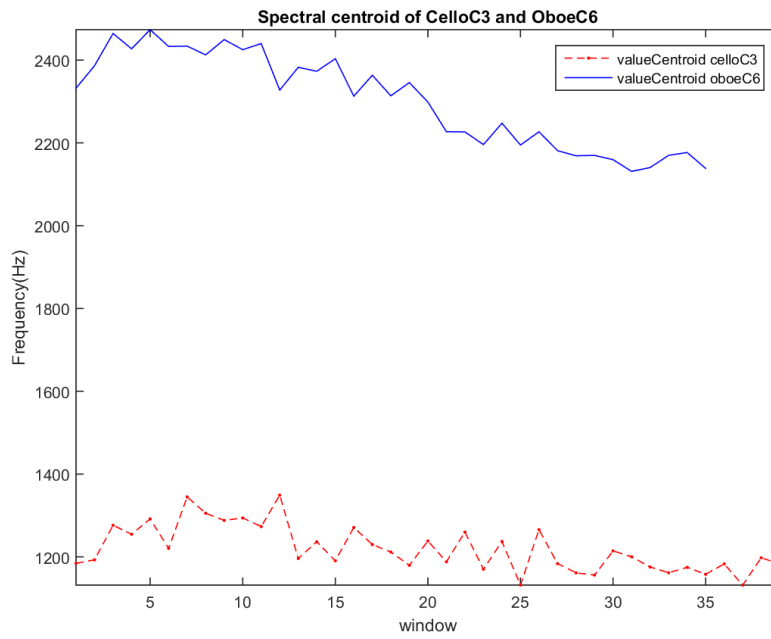

Figure 3.2: Values of the spectral centroid of the violoncello C3 and oboe C6 sounds

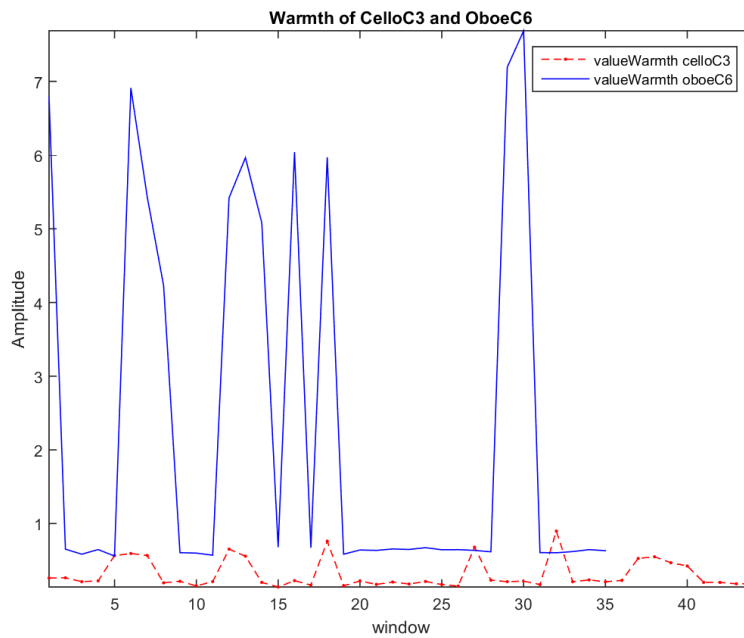

Figure 3.3: Values of warmth of the violoncello C3 and oboe C6 sounds

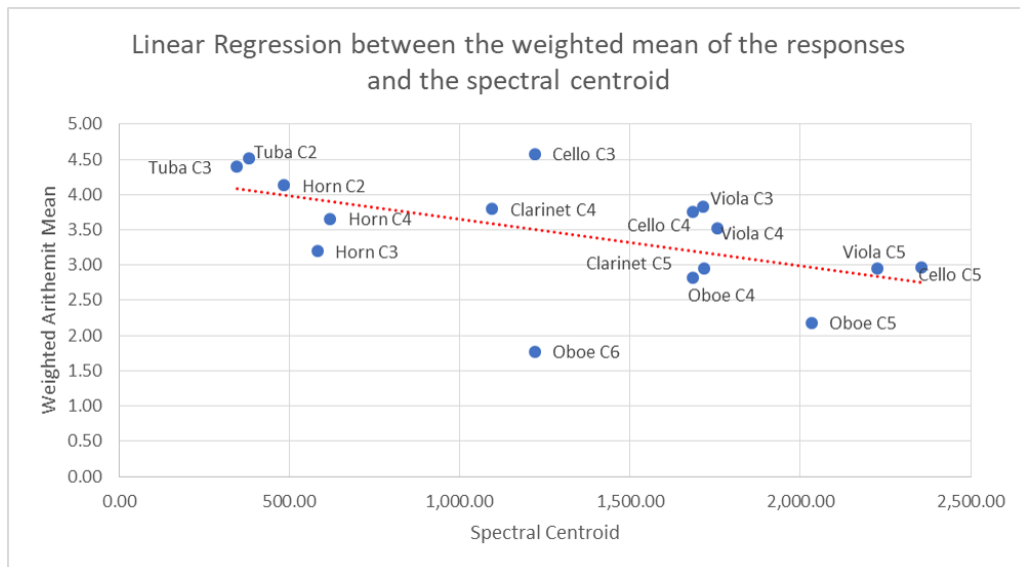

Figure 3.4: Linear regression between the weighted arithmetic mean evaluation and the spectral centroid of all instrumental sounds



Figure 3.5: Linear regression between the weighted arithmetic mean evaluation and the warmth of all instrumental sounds

| Instruments                   | Octave | Warmth                       | Spectral Centroid | Ratio between warmth and the spectral centroid |
|-------------------------------|--------|------------------------------|-------------------|--|
| Tuba                          | C2     | 0.29                         | 382.23            | 0.075%   |
|                               | C3     | 3.83                         | 345.29            | 1.108%   |
|                               | C4     | 66.95                        | 347.95            | 19.241%  |
| Horn                          | C2     | 0.22                         | 484.42            | 0.045%   |
|                               | C3     | 1.70                         | 582.37            | 0.292%   |
|                               | C4     | 4.54                         | 619.72            | 0.733%   |
| Clarinet                      | C4     | 1.34                         | 1,095.70          | 0.122%   |
|                               | C5     | 2.62                         | 1,717.00          | 0.153%   |
|                               | C6     | 23.00                        | 1,981.50          | 1.161%   |
| Oboe                          | C4     | 0.13                         | 1,682.70          | 0.008%   |
|                               | C5     | 1.79                         | 2,034.00          | 0.088%   |
|                               | C6     | 2.34                         | 1,219.50          | 0.192%   |
| Viola                         | C3     | 0.39                         | 1,712.90          | 0.023%   |
|                               | C4     | 0.37                         | 1,757.70          | 0.021%   |
|                               | C5     | 0.35                         | 2,226.30          | 0.016%   |
| Cello                         | C3     | 0.87                         | 1,219.50          | 0.071%   |
|                               | C4     | 0.31                         | 1,684.00          | 0.019%   |
|                               | C5     | 1.07                         | 2,354.80          | 0.046%   |
| Pearson correlation ( $r_s$ ) |        | -0.279<br>p-value = 0.262218 |                   |  |

Table 3.4: Values of warmth and spectral centroid of each instrumental sound. A ratio between the warmth and the spectral centroid is also calculated. The present Pearson correlation value result of correlation between the values of warmth and the values of the spectral centroid

by the correlation value present in Table 3.4 where the the values of warmth and the values of the spectral centroid have a poor Pearson correlation of -0.279.

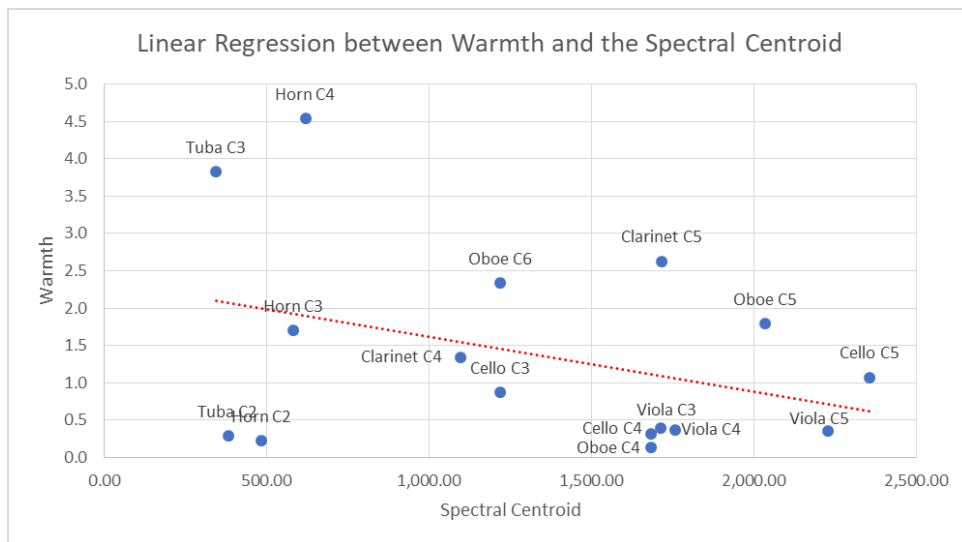

Figure 3.6: Linear regression between the warmth and the spectral centroid of all instrumental sounds



# Chapter 4

## Development of the system

In this chapter we describe, in detail, the development of the system, created in Pure Data[35], that allows producers and musicians to manipulate the warmth of monophonic harmonic audio in real-time (e.g., of a live performance).

### 4.1 System Overview

Based on the new linear combination resulting from our listening test, we developed a (one-knob) audio effect which allows users to transform the warmth of a sound in real-time. To this end, we regulate the amplitudes of the spectral components of a musical audio, to shape them according to a relative user-controlled level of warmth. In other words, we allow user to dynamically reduce or increase the percentage of warmness in the musical audio input while retaining the relative variability over time.

Yet, due to its subjective nature, it's hard to define it with a mathematical model, which would enable us to manipulate sounds using digital signal processing techniques. Therefore, by being aware of the importance of such a processing tool, we strive here to first understand the timbral attributes which impact such an informal sonic attribute and secondly encode it as a mathematical model which can be used to manipulate the warmth of musical audio in real-time.

The architecture of our system is shown in Figure 4.1. After receiving the input audio file, the system first calculates the warmth region (WR) and the remainder magnitude (RM) as outputs. These outputs are then processed by a resynthesis algorithm. This algorithm takes the user input, which will control the level of warmth that he wants in the output audio file.

### 4.2 Definition of the Warmth Region

In order to define the warmth region, we use Williams and Brookes' metric, explained in Section 2.5.1.1. They defend that the warmth region is the area encompassing the energy

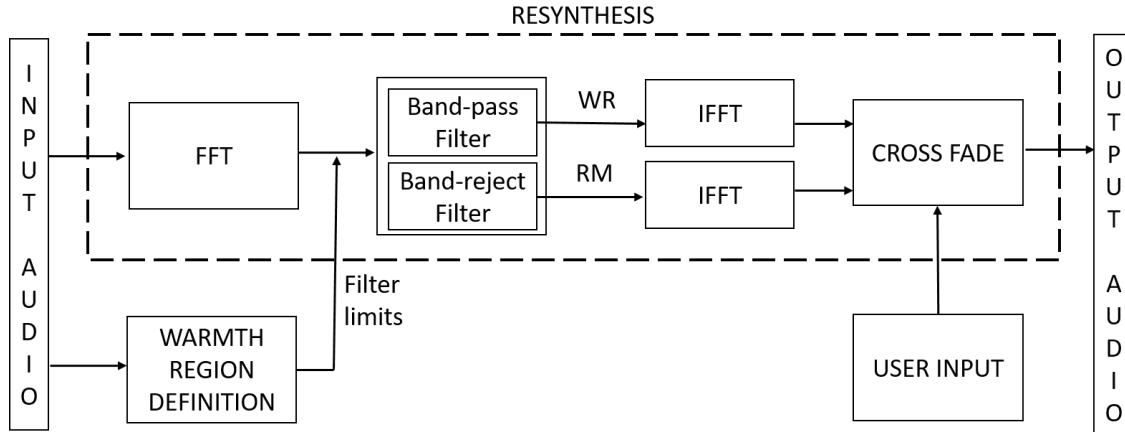

Figure 4.1: System Architecture

of the first three harmonics.

Following [1], we define the warmth region as a ratio between the energy of the first three harmonics (WR) - using Equation 2.14 - and the remainder magnitude (RM) of the spectrum - using Equation 2.15.

For this we developed a routine using Pure Data programming environment [35], that can be seen in Figure A.2. In the core of the patch is the use of *Sigmund*, a sinusoidal analysis and pitch tracking pure data object, developed by Puckette, that allows us to acquire information regarding the envelope, the peaks and pitch from the audio file. Since we are analyzing audio files, with a sampling rate of 441kHz, we use an analysis windows of 8192 samples which gives us an adequate frequency resolution for spectral analysis, as seen in Table 4.1 using Equation 4.1. The hop (number of points between analysis) is one fourth of the analysis windows (2048).

| Number of bins of the FFT (N)    | 128    | 256    | 512   | 1024  | 2048  | 4096  | 8192 |
|----------------------------------|--------|--------|-------|-------|-------|-------|------|
| Lowest Detectable Frequency (Hz) | 344.53 | 172.27 | 86.13 | 43.07 | 21.53 | 10.77 | 5.38 |

Table 4.1: Lowest Detectable Frequency according to the FFT window size, considering 44100Hz the sampling rate

$$df = \frac{f_s}{N} \quad (4.1)$$

Where:

df is the Lowest Detectable Frequency (frequency resolution);

$f_s$  is the sampling rate;

N is the number of sample acquired.

After analyzing the spectrum in the warmth region, we create a table which contains the information of the first three harmonics. This table is then sent to the resynthesis

module, which is explained in the following section (Section 4.3). Figure 4.2 shows the first three harmonics of the viola C4 sound.

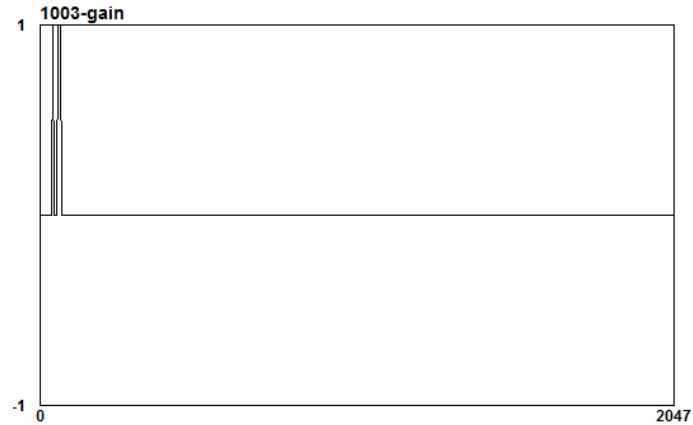

Figure 4.2: First three harmonics of a Viola C4 sound

### 4.3 Resynthesis

The resynthesis module is responsible for filtering the audio signal and then modify its amplitude based on a user input, in order to sound warmer or colder.

The algorithm starts by multiplying the audio with an Hann window, with half the size of the Fast Fourier Transform (FFT) window, in order to reduce the amplitude of the discontinuities at the boundaries of each block sequence. Then, it performs an FFT with a window size of 8192 Hz (Table 4.1), with an overlap of four sequence blocks. In Figure 4.3 we see an example where the window size is  $n$  and the hop size is one fourth of the window size.

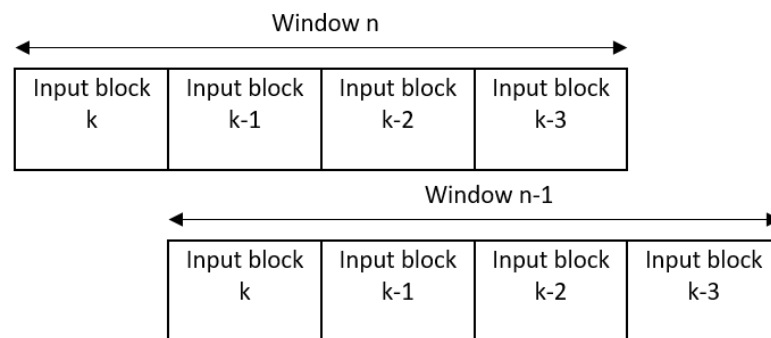

Figure 4.3: Example of a window with overlap of four blocks

Then, we perform a convolution of the audio and the received WR table. This table works as a band-pass filter and also as a reject-band filter.

As a band-pass filter (Figure 4.4), it only allows the parts of the signal that are within the warmth region, in other word, between the central frequency and 3.5 times the central frequency, and all others frequencies are attenuated.

As a reject-band filter (Figure 4.5) it does the opposite, allowing only the parts of the signal that are outside the warmth region.

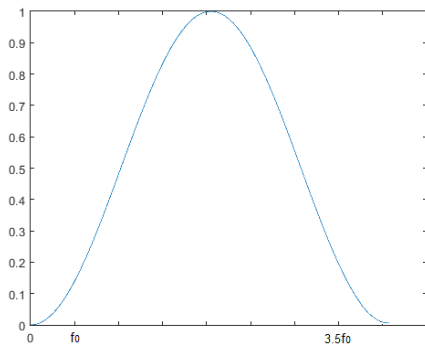

Figure 4.4: Band-pass filter where only the values within the warmth region are allowed, and the rest is attenuated

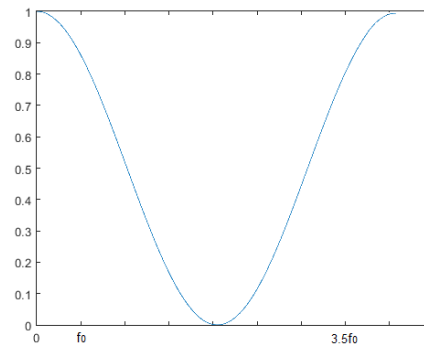

Figure 4.5: Reject-band filter where the amplitudes within the warmth region are attenuated

At last, both signals are normalized and reconstructed to time domain using the Inverted Fast Fourier Transform (IFFT) and multiplied, once again, by the Hann window in order to correct the zero-crossing. Then, they go through a cross fade operation before outputting the audio file.

### 4.3.1 Crossfade

This module performs a crossfade between the signal corresponding to the warmth region and the signal corresponding to everything else, except the warmth region. This operation consists in the manipulation of the the warmth region according to a variation of a user input value.

$$crossfade = A + XB \quad (4.2)$$

Where:

$A$  corresponds to the signal after passing through the band-pass filter;

$B$  corresponds to the signal after passing through the reject-band filter;

$X$  corresponds to a value controlled by a user input.

## Chapter 5

# Evaluation of the system

This chapter starts by explaining the listening experiment used to evaluate the effectiveness of the system. Then we present and comment on the results from the listening test.

Lastly, we analyze the new values of warmth and spectral centroid of the transformed sounds and compare them to their original sound.

### 5.1 Listening Test

In order to evaluate the performance of our system, we conducted a second online listening experiment<sup>1</sup> of a set of instrumental sounds.

Based on the responses of the first listening test, the violoncello was the instrument with a warmer evaluation overall. In this regard, we selected the highest octave (C5) in order to evaluate if the variation of its warmth would be perceived. This same octave was selected for all the others instruments, except for the horn where we used the octave C4, which is the highest octave available.

To perform an objective evaluation of the system, we modified each instrument according to different degrees of warmth. Specifically, we increased the warmth by 25% and 50% and decreased the warmth by 25% and 50%. The test can be found in Appendix A.4.

In the survey, participants were asked to rate on a 5-point Likert scale (1-5) the difference in warmth between the two available audio, where 1 corresponds to the modified sound being much warmer than the original sound, 3 corresponds to no prominent difference between the two sounds, and 5 corresponds to evaluating the modified sound as much colder than the original sound.

Before rating, the participants were asked to find a quiet place and listen to the full extent of both audio examples using high quality headphones.

In order to submit their ratings and complete the listening test, the participants were obliged to rate all sound examples. To prevent responses bias introduced by order effects, the musical examples were presented in a random order at each experiment trial.

---

<sup>1</sup>The listening test is available at <http://npires91.polladdy.com/s/listening-test-2>

## 5.2 Results

In total, 52 individuals (38 male and 14 female) ranging from 15 to 40 years old participated in the experiment. Twenty three participants claimed to have *no expertise in music production creation and performance*, 25 claimed to have *some expertise in music production, creation and performance* and the remaining 4 claimed to have *high expertise in music production, creation and performance*.

In Figure 5.1 it is possible to visualize the results of the listening test in more graphical representation. In column “Manipulation” the gradient varies from turquoise to orange, where the first represents the lowest degree of warmth, that is minus 50% warmth, followed by a grayish blue representing minus 25% warmth. The original file (with no transformation) has a light grey color. The transformation for increased warmth are represented by yellow (plus 25%) and orange (plus 50%).

| Instruments                 | Manipulation | Warmth      | Centroid        | Ratio da Warmth com a Centroid | 5           | 4            | 3             | 2            | 1           |
|-----------------------------|--------------|-------------|-----------------|--------------------------------|-------------|--------------|---------------|--------------|-------------|
|                             |              |             |                 |                                | Much warmer | A bit warmer | No difference | A bit colder | Much colder |
| Horn C4                     | 50% warmth   | 49.52       | 1,131.70        | 4.376%                         | 13          | 10           | 4             | 14           | 10          |
|                             | 25% warmth   | 20.64       | 1,452.70        | 1.421%                         | 9           | 16           | 4             | 19           | 3           |
|                             | original     | <b>4.54</b> | <b>582.37</b>   | <b>0.780%</b>                  | 2           | 7            | 39            | 3            | 0           |
|                             | 25% cold     | 4.69        | 1,356.70        | 0.346%                         | 0           | 9            | 36            | 5            | 1           |
|                             | 50% cold     | 3.52        | 1,425.50        | 0.247%                         | 1           | 15           | 28            | 7            | 0           |
| Clarinet C5                 | 50% warmth   | 9.81        | 1,992.60        | 0.493%                         | 13          | 15           | 5             | 12           | 6           |
|                             | 25% warmth   | 4.83        | 1,783.70        | 0.271%                         | 3           | 19           | 8             | 14           | 7           |
|                             | original     | <b>2.62</b> | <b>1,717.00</b> | <b>0.153%</b>                  | 1           | 9            | 36            | 4            | 1           |
|                             | 25% cold     | 2.69        | 2,255.60        | 0.119%                         | 4           | 15           | 12            | 14           | 6           |
|                             | 50% cold     | 2.77        | 2,336.60        | 0.118%                         | 9           | 13           | 9             | 13           | 7           |
| Oboe C5                     | 50% warmth   | 10.02       | 1,944.70        | 0.515%                         | 15          | 12           | 3             | 17           | 4           |
|                             | 25% warmth   | 5.89        | 1,901.90        | 0.310%                         | 6           | 26           | 4             | 14           | 1           |
|                             | original     | <b>1.79</b> | <b>2,034.00</b> | <b>0.088%</b>                  | 1           | 4            | 41            | 4            | 1           |
|                             | 25% cold     | 1.96        | 2,524.00        | 0.078%                         | 2           | 2            | 42            | 4            | 1           |
|                             | 50% cold     | 1.66        | 2,533.10        | 0.066%                         | 6           | 22           | 1             | 16           | 6           |
| Viola C5                    | 50% warmth   | 2.85        | 1,834.60        | 0.155%                         | 11          | 19           | 3             | 11           | 7           |
|                             | 25% warmth   | 1.57        | 2,034.90        | 0.077%                         | 4           | 18           | 11            | 13           | 5           |
|                             | original     | <b>0.35</b> | <b>2,226.30</b> | <b>0.016%</b>                  | 0           | 2            | 44            | 5            | 0           |
|                             | 25% cold     | 0.50        | 2,784.60        | 0.018%                         | 1           | 13           | 21            | 11           | 5           |
|                             | 50% cold     | 0.45        | 2,655.60        | 0.017%                         | 3           | 4            | 20            | 21           | 3           |
| Cello C5                    | 50% warmth   | 9.60        | 1,786.30        | 0.537%                         | 15          | 11           | 2             | 14           | 9           |
|                             | 25% warmth   | 4.27        | 2,194.70        | 0.195%                         | 5           | 23           | 6             | 13           | 4           |
|                             | original     | <b>1.07</b> | <b>2,354.80</b> | <b>0.045%</b>                  | 0           | 2            | 46            | 3            | 0           |
|                             | 25% cold     | 1.26        | 2,275.91        | 0.055%                         | 3           | 7            | 33            | 8            | 0           |
|                             | 50% cold     | 1.01        | 2,822.40        | 0.036%                         | 1           | 10           | 24            | 14           | 2           |
| <b>Manipulation legend:</b> | much warmth  | bit warmth  |                 | bit colder                     | much colder |              |               |              |             |

Figure 5.1: Responses of the second listening test with a graphical color code representation

We also highlight the responses, where red represents the evaluation of warmth with the most responses and orange representing the evaluation of warmth with the second most responses. Once again, all modified sounds were evaluated in comparison to the original, unmodified sound.

Taking a close look at the responses for the horn, in Table 5.1, we verify that the increase in warmth was not well perceived because half the responses were either warmer or colder. The decrease of warmth was also not noticed, as the majority answered “*No difference*”.

The 25% increase of warmth on woodwinds instruments was noticeable by the majority. For an 50% increase in clarinet’s warmth, this change was well grasped as participants evaluated this transformation as warmer than the original. The same can not be said

for the oboe because; for this same transformation of warmth, the participants equally evaluated as warmer and colder. The decrease of warmth, on both clarinet and oboe, was also not grasped as participants determined it as both warmer and colder.

|             | Range        | 5           | 4            | 3             | 2            | 1           |
|-------------|--------------|-------------|--------------|---------------|--------------|-------------|
| Instruments | Manipulation | Much warmer | A bit warmer | No difference | A bit colder | Much colder |
| Horn C4     | 50% warmth   | 13          | 10           | 4             | 14           | 10          |
|             | 25% warmth   | 9           | 16           | 4             | 19           | 3           |
|             | original     | 2           | 7            | 39            | 3            | 0           |
|             | 25% cold     | 0           | 9            | 36            | 5            | 1           |
|             | 50% cold     | 1           | 15           | 28            | 7            | 0           |
| Clarinet C5 | 50% warmth   | 13          | 15           | 5             | 12           | 6           |
|             | 25% warmth   | 3           | 19           | 8             | 14           | 7           |
|             | original     | 1           | 9            | 36            | 4            | 1           |
|             | 25% cold     | 4           | 15           | 12            | 14           | 6           |
|             | 50% cold     | 9           | 13           | 9             | 13           | 7           |
| Oboe C5     | 50% warmth   | 15          | 12           | 3             | 17           | 4           |
|             | 25% warmth   | 6           | 26           | 4             | 14           | 1           |
|             | original     | 1           | 4            | 41            | 4            | 1           |
|             | 25% cold     | 2           | 2            | 42            | 4            | 1           |
|             | 50% cold     | 6           | 22           | 1             | 16           | 6           |
| Viola C5    | 50% warmth   | 11          | 19           | 3             | 11           | 7           |
|             | 25% warmth   | 4           | 18           | 11            | 13           | 5           |
|             | original     | 0           | 2            | 44            | 5            | 0           |
|             | 25% cold     | 1           | 13           | 21            | 11           | 5           |
|             | 50% cold     | 3           | 4            | 20            | 21           | 3           |
| Cello C5    | 50% warmth   | 15          | 11           | 2             | 14           | 9           |
|             | 25% warmth   | 5           | 23           | 6             | 13           | 4           |
|             | original     | 0           | 2            | 46            | 3            | 0           |
|             | 25% cold     | 3           | 7            | 33            | 8            | 0           |
|             | 50% cold     | 1           | 10           | 24            | 14           | 2           |

Table 5.1: Responses of the second listening test that aimed to evaluate the system

However, the responses for the increase of warmth on the string instrumental sounds were positive as the majority of the participants perceived this transformation as warmer. The same cannot be said for the decrease in warmth as most of the participants couldn't differ the modified audio from the original.

In order to know which sound was evaluated as the warmest, and least warm, after the manipulation, we calculated a weighted arithmetic mean of the results, where each evaluation had the weight from 1 to 5 where, this time, 1 represents “*Much colder*” and 5 represents “*Much warmer*”. This way the higher the weighted mean the warmer the sound, and vice versa. With Table 5.2 we conclude that the sound of the oboe C5 with an increase of 25% warmth was the warmest sound and, on the other hand, the sound of the viola C5 with a decrease of warmth in 50% was the least warm sound of the data

| Instruments                                     | Manipulation | Weighted Mean                | Variance | Std  |
|---|--------------|------------------------------|----------|------|
| Horn C4   | 50% warmth   | 3.04                         | 2.27     | 1.51 |
|   | 25% warmth   | 3.18                         | 1.60     | 1.26 |
|   | original     | 3.16                         | 0.33     | 0.57 |
|   | 25% cold     | 3.04                         | 0.35     | 0.59 |
|   | 50% cold     | 3.20                         | 0.47     | 0.69 |
| Clarinet C5                                     | 50% warmth   | 3.33                         | 1.91     | 1.38 |
|   | 25% warmth   | 2.94                         | 1.43     | 1.19 |
|   | original     | 3.10                         | 0.40     | 0.63 |
|   | 25% cold     | 2.94                         | 1.35     | 1.16 |
|   | 50% cold     | 3.08                         | 1.76     | 1.33 |
| Oboe C5   | 50% warmth   | 3.33                         | 1.95     | 1.40 |
|   | 25% warmth   | 3.43                         | 1.15     | 1.07 |
|   | original     | 3.00                         | 0.31     | 0.56 |
|   | 25% cold     | 3.00                         | 0.35     | 0.59 |
|   | 50% cold     | 3.12                         | 1.67     | 1.29 |
| Viola C5  | 50% warmth   | 3.31                         | 1.90     | 1.38 |
|   | 25% warmth   | 3.06                         | 1.31     | 1.14 |
|   | original     | 2.94                         | 0.13     | 0.37 |
|   | 25% cold     | 2.88                         | 0.93     | 0.96 |
|   | 50% cold     | 2.67                         | 0.85     | 0.92 |
| Cello C5  | 50% warmth   | 3.18                         | 2.34     | 1.53 |
|   | 25% warmth   | 3.24                         | 1.36     | 1.16 |
|   | original     | 2.98                         | 0.10     | 0.31 |
|   | 25% cold     | 3.10                         | 0.52     | 0.72 |
|   | 50% cold     | 2.88                         | 0.69     | 0.83 |
| Warmth Pearson correlation ( $r_s$ )            |              | 0.175<br>p-value = 0.400859  |          |      |
| Spectral Centroid Pearson correlation ( $r_s$ ) |              | -0.427<br>p-value = 0.033268 |          |      |

Table 5.2: Weighted arithmetic mean, variance and standard deviation of the results of the second listening test. The present Pearson correlation values result from a correlation between the values of warmth and the weighted mean values and also from a correlation between the values of the spectral centroid and the weighted mean values.

set. We can also observe that the spectral centroid still has a significant correlation with the weighted mean of the evaluation, as the Pearson correlation value is -0.427. Although the correlation value has improved in relation to the first test, the warmth still has a poor correlation with the weighted mean evaluation with a Pearson correlation of 0.175. The linear regression between the spectral centroid and the weighted mean can be seen in Figure A.90 and Figure A.91. The linear regression between warmth and the weighted mean can be seen in Figure A.92 and Figure A.93.

If we compare the results of the two listening tests it is interesting to notice that the oboe C5 was evaluated as one of the least warm sounds of the data set, and after the transformation it became much warmer. Yet, the sound of viola C5 remained as one of

the least warm sounds of the data set.

### 5.3 Analysis of the manipulated instrumental sounds

For analyzing the warmth and spectral centroid of the transformed audio file, we used the same pure data patch (Figure A.2). In Table 5.3 we present the mean and standard deviation of warmth and spectral centroid. All the results and plots were compiled, analyzed and generated using a Matlab script.

| Instruments                   | Manipulation | Warmth                       | Spectral centroid | Ratio between warmth and the spectral centroid |
|-------------------------------|--------------|------------------------------|-------------------|--|
| Horn C4                       | 50% warmth   | 49.52                        | 1,131.70          | 4.376%   |
|                               | 25% warmth   | 20.64                        | 1,452.70          | 1.421%   |
|                               | original     | 4.54                         | 582.37            | 0.780%   |
|                               | 25% cold     | 4.69                         | 1,356.70          | 0.346%   |
|                               | 50% cold     | 3.52                         | 1,425.50          | 0.247%   |
| Clarinet C5                   | 50% warmth   | 9.81                         | 1,992.60          | 0.493%   |
|                               | 25% warmth   | 4.83                         | 1,783.70          | 0.271%   |
|                               | original     | 2.62                         | 1,717.00          | 0.153%   |
|                               | 25% cold     | 2.69                         | 2,255.60          | 0.119%   |
|                               | 50% cold     | 2.77                         | 2,336.60          | 0.118%   |
| Oboe C5                       | 50% warmth   | 10.02                        | 1,944.70          | 0.515%   |
|                               | 25% warmth   | 5.89                         | 1,901.90          | 0.310%   |
|                               | original     | 1.79                         | 2,034.00          | 0.088%   |
|                               | 25% cold     | 1.96                         | 2,524.00          | 0.078%   |
|                               | 50% cold     | 1.66                         | 2,533.10          | 0.066%   |
| Viola C5                      | 50% warmth   | 2.85                         | 1,834.60          | 0.155%   |
|                               | 25% warmth   | 1.57                         | 2,034.90          | 0.077%   |
|                               | original     | 0.35                         | 2,226.30          | 0.016%   |
|                               | 25% cold     | 0.50                         | 2,784.60          | 0.018%   |
|                               | 50% cold     | 0.45                         | 2,655.60          | 0.017%   |
| Cello C5                      | 50% warmth   | 9.60                         | 1,786.30          | 0.537%   |
|                               | 25% warmth   | 4.27                         | 2,194.70          | 0.195%   |
|                               | original     | 1.07                         | 2,354.80          | 0.045%   |
|                               | 25% cold     | 1.26                         | 2,275.91          | 0.055%   |
|                               | 50% cold     | 1.01                         | 2,822.40          | 0.036%   |
| Pearson correlation ( $r_s$ ) |              | -0.498<br>p-value = 0.012902 |                   |  |

Table 5.3: Calculation of the Warmth and Spectral Centroid of each instrumental sounds that were modified according to a certain degree of warmth. It was also calculated the ratio between warmth and the centroid. The present Pearson correlation value result of the correlation between the values of warmth and the values of the spectral centroid.

Since the oboe C5, with increased 25% warmth, was evaluated as the most warm sound in the second listening test, we're going to use it as an example of the results of the

transformed sounds.

In Figure 5.2 and Figure 5.3 it is possible to see the variation of warmth of the different oboe C5 sounds, in each analysis window. We can see that the more we increase the warmth in the sound the lower its spectral centroid is. The opposite is not true, as the spectral centroid of the three sounds have similar variation.

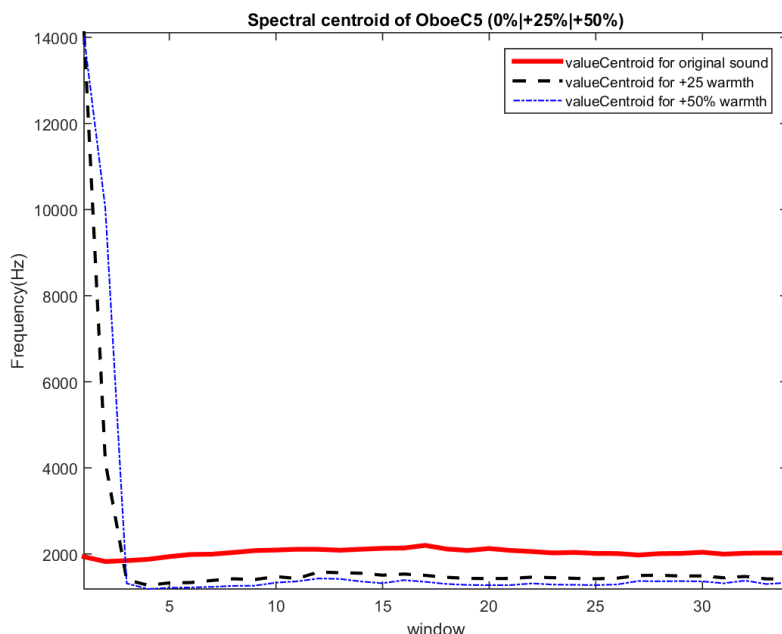

Figure 5.2: Values of the Spectral Centroid of the oboe C5 with 0%,+25% and +50% warmth

In Figure 5.4 and Figure 5.5 we present the variation of warmth when increased and decreased, respectively, in each analysis window. We can see that with the increase of warmth, the sound has greater amplitude and it also has a greater oscillation of the values. When decreasing the warmth in the sounds, the values vary within almost the same range, but it would be expected that for lower warmth we see a plot with oscillation with less amplitude.

This conclusion is the same for the other transformed sounds (clarinet C5, viola C5, violoncello C5 and horn C4).

After all the in-depth analysis on the manipulated sounds, we verify (Table 5.3) that the warmth and the spectral centroid have a higher and more significant Pearson correlation of -0.498, and a p-value of 0.01, opposite to the correlation value of the first listening test.

We can conclude that the system works for when we intend to increased the warmth in the sound. However, for variations in the quality of cold (decrease of warmth) do not follow a linear evolution. This means that the perceptions are very tenuous for variations up to 50% of the original sound. This explains why the listeners responded mostly “*No Difference*” for the variation of the attribute cold of the sound, as we can see in Table 4.3.

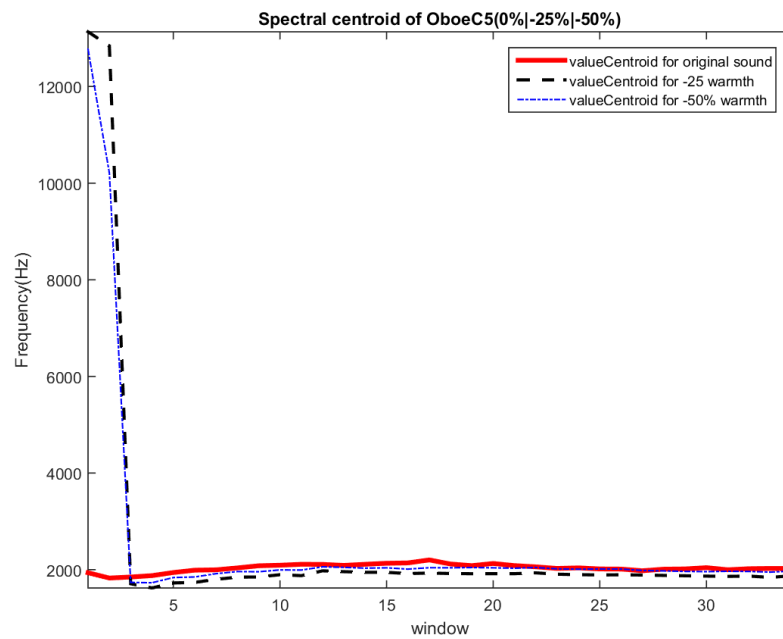

Figure 5.3: Values of the Spectral Centroid of the oboe C5 with 0%, -25% and -50% warmth

It is necessary to think of another way of approaching how to decrease the warmth in the sound.

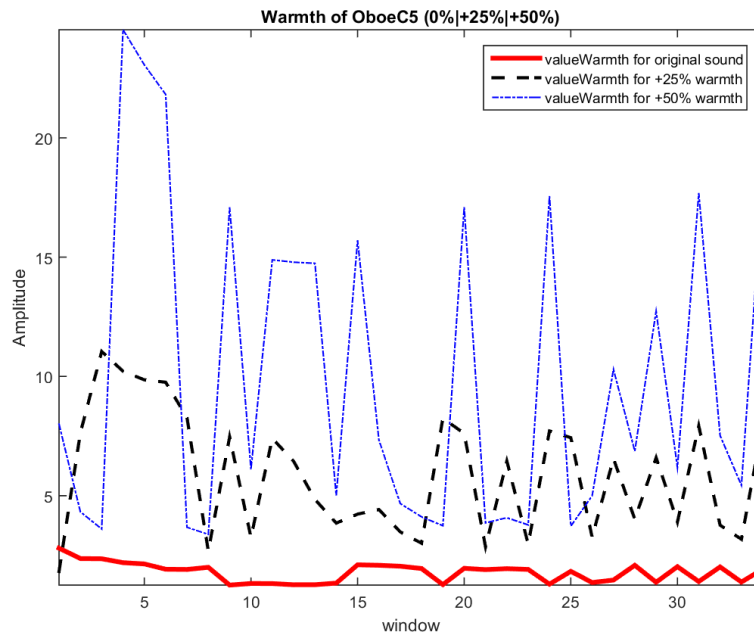

Figure 5.4: Values of the Spectral Centroid of the oboe C5 with 0%, +25% and +50% warmth

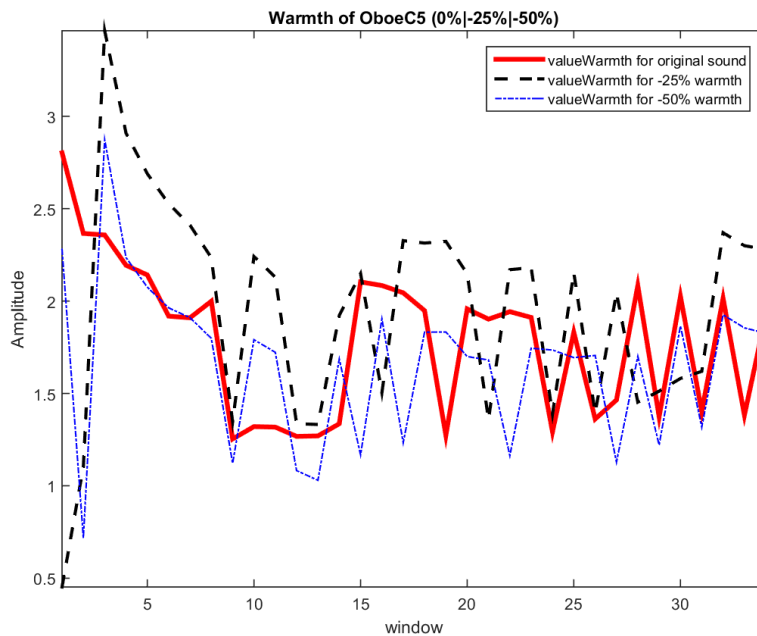

Figure 5.5: Values of the Spectral Centroid of the oboe C5 with 0%, -25% and -50% warmth

## Chapter 6

# Conclusion and Future Work

### 6.1 Summary

The focus of this dissertation was to revalidate an existing model for description of warmth in sound and to create an application that allows its manipulation in real time.

To achieve this goal we started by studying the existing metrics. Williams and Brookes [1] refer that warmth has a correlation with the spectral slope, the spectral centroid and the relation between the energy of the first three harmonics and the magnitude of the rest of the spectrum.

But to first try to understand how warmth is perceived we created a listening test on which the listeners had to evaluate the level of warmth of the monophonic instrumental sounds.

Subsequently, we developed an application, based on William's metric that performs a spectral analysis of the sound and outputs the values of warmth and spectral centroid and also their respective statistic related values, such as mean and standard deviation.

After analyzing the sounds in the data set, we updated our system in order to be able to manipulate the warmth in a sound according to a user input, in real time.

To evaluate the effectiveness of our system, we devised a second listening experiment where the participants had to, in each question, rate the level of warmth between the two sounds. For this data set we selected a few sounds, from the previous experiment's data set, to be transformed. This means that we modified the sounds so that they have increased and decreased warmth.

### 6.2 Conclusion and Future work

With this dissertation, we can better understand what warmth is and how it is perceived. Still, it was not possible to correlate the warmth and the spectral centroid.

Despite the non significant correlation between the variation of warmth and the evaluations, we were able to correlate the warmth with the spectral centroid, getting a

Pearson correlation value of -0.498 (p-value = 0.013). We conclude that the algorithm of selecting and manipulating the warmth region still has to be polished and perfected. When we increase the warmth of a sound we can feel its change and feel the sound getting warmer. Of course this variation is better felt in the string instruments and less in the brass instruments. On the other hand, the decrease of the level of warmth is not well perceived, mostly when decreasing its value below 50%, as in this case the difference in warmth is not perceived at all.

For this reason, further testing is necessary and possibly a new and different approach on how to manipulate the warmth. For example, one which includes the spectral centroid as a factor for the manipulation of warmth. It may be necessary to assign different weights to the warmth and the spectral centroid.

When crossing to polyphonic sounds, the algorithm would have to be readjusted taking into account the transition bands and also the zero-crossing.

# Appendix A

## Appendix

### A.1 Pure Data Code

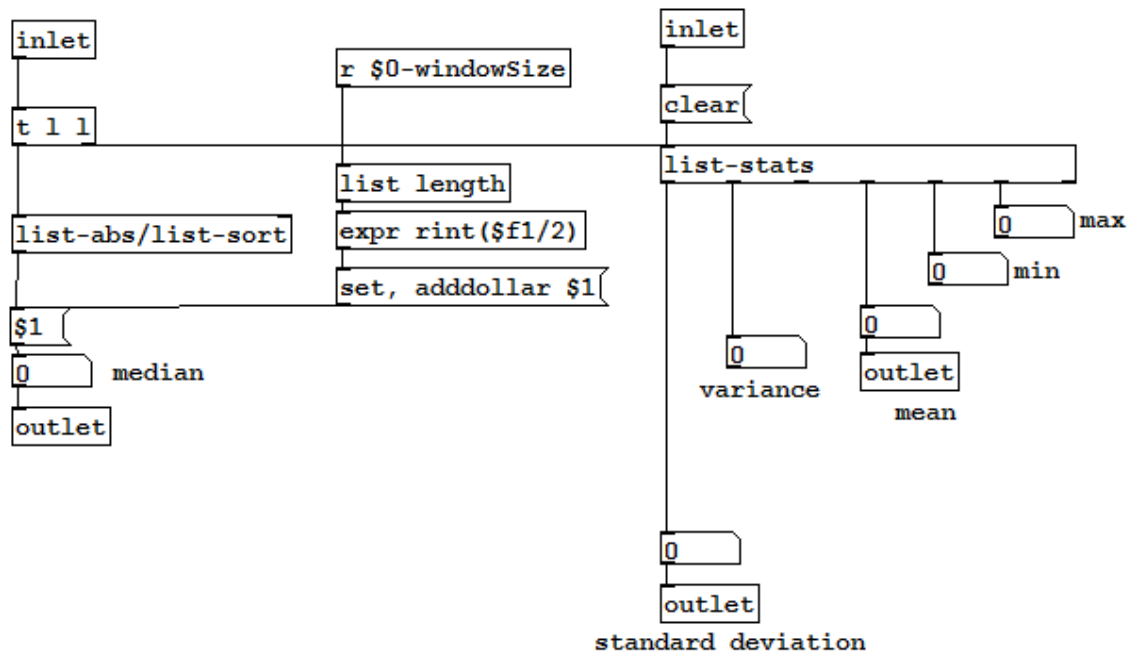

Figure A.1: Pure Data patch that receives the values of the Warmth Region and Spectral Centroid of all frames and calculates the mean, media, and standard deviation

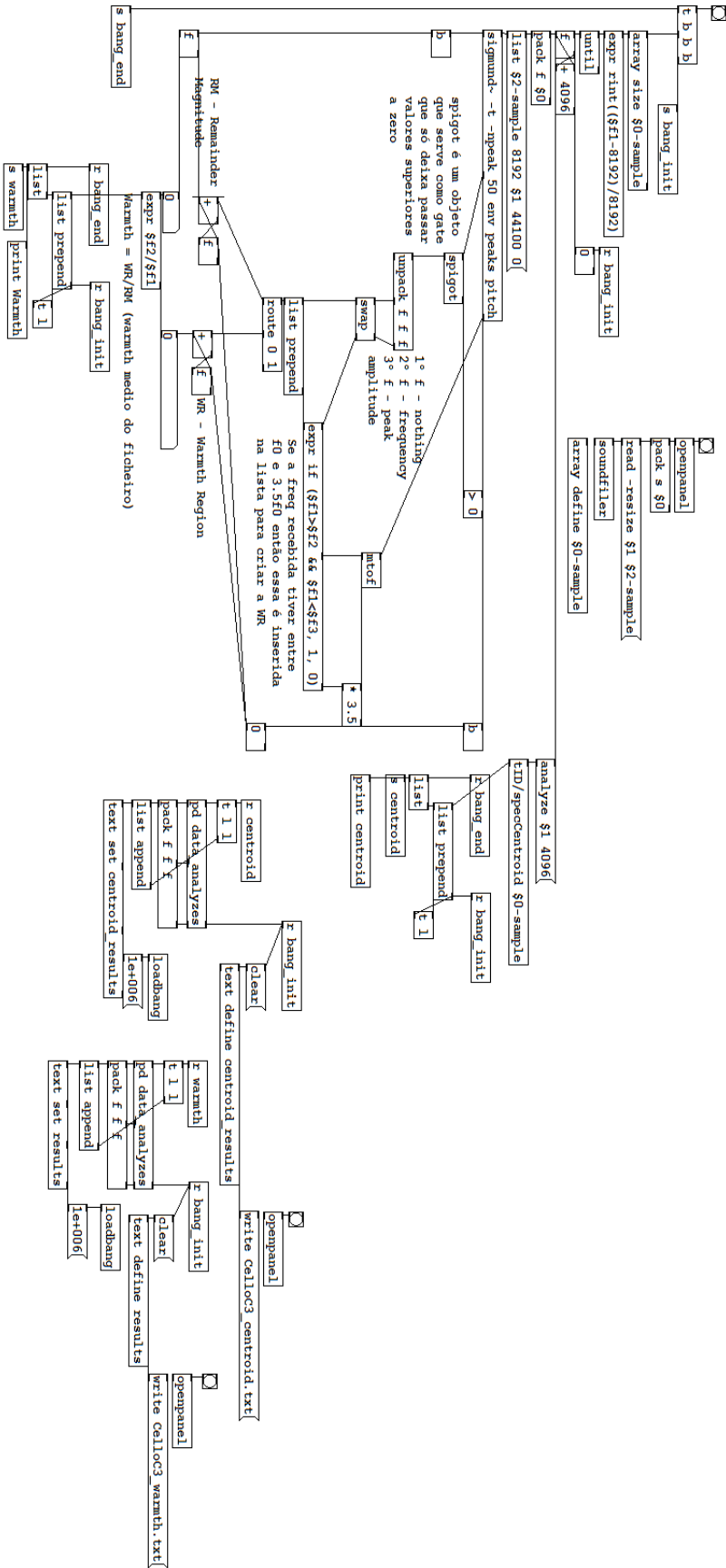

Figure A.2: Pure Data patch that calculates the Warmth Region and the Spectral Centroid

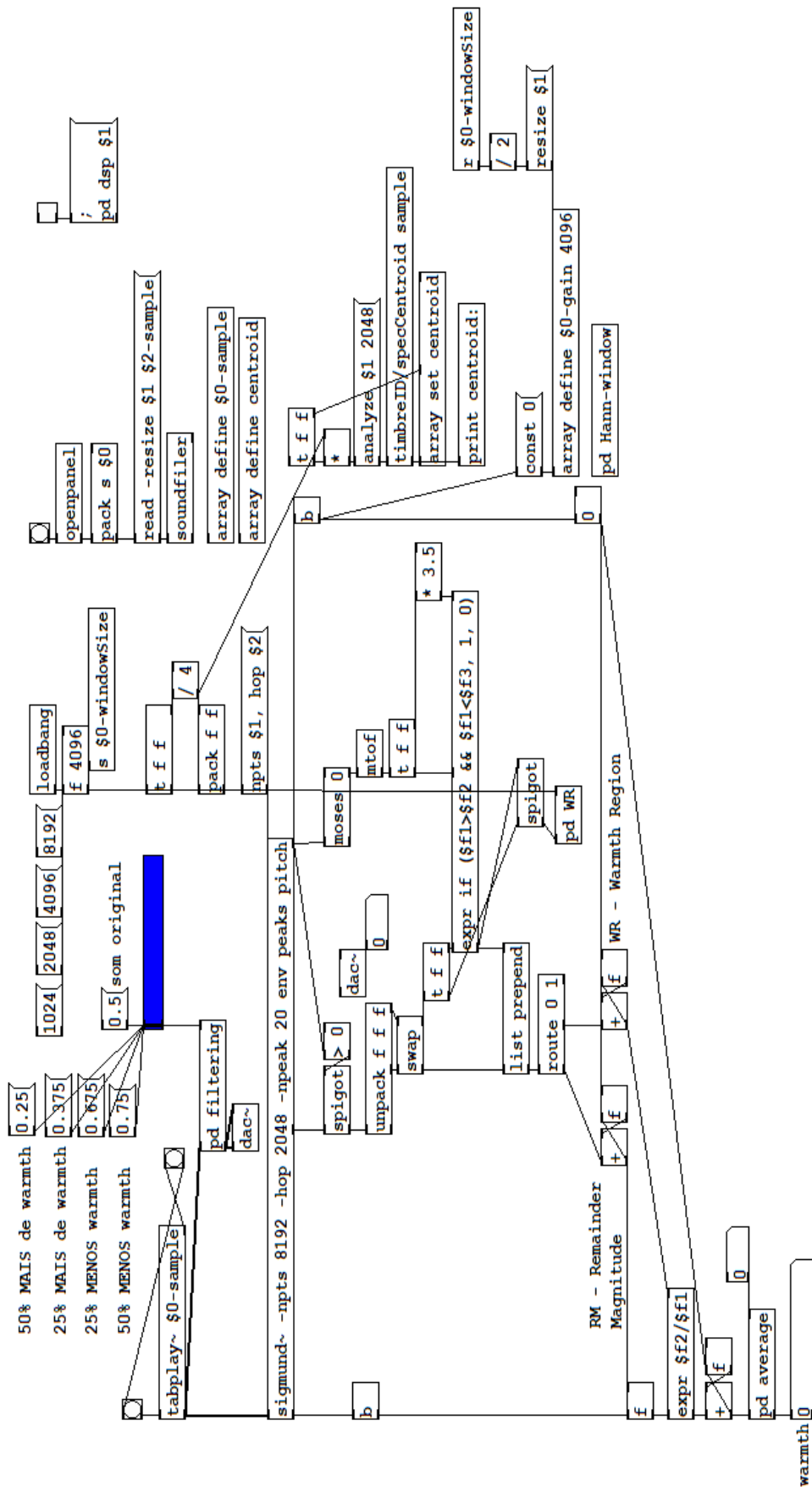

Figure A.3: Pure Data patch relative to the manipulation of the Warmth Region in real-time

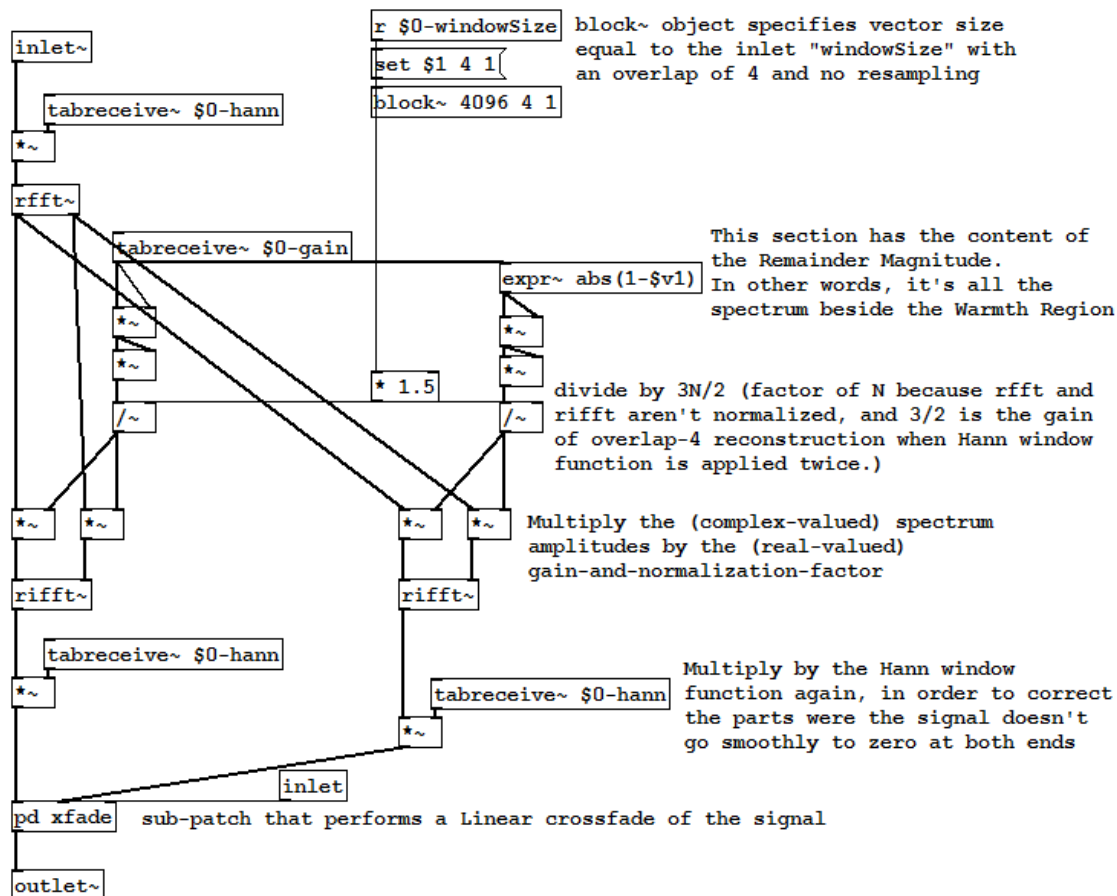

Figure A.4: Pure Data patch that performs the FFT of the signal, applies a band-pass filter and reject-band filter in order to get part of the signal related to the Warmth Region and the Remainder Magnitude, respectively, and allow the manipulation of the Warmth Region

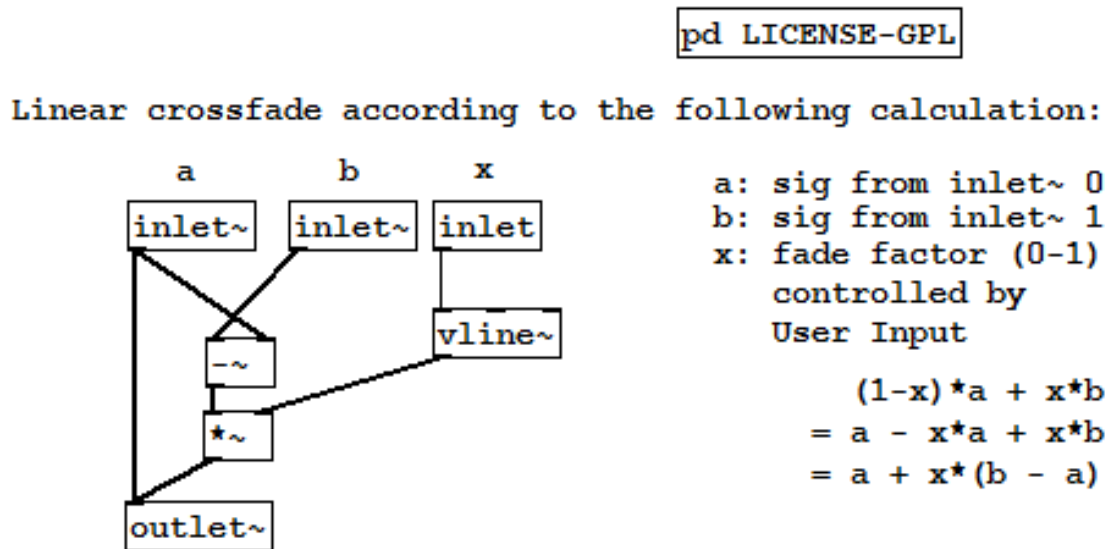

Figure A.5: Pure Data patch that performs the manipulation of the warmth region based on a user input

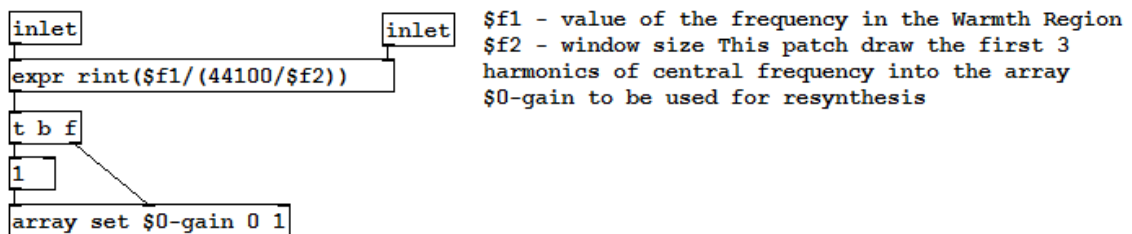
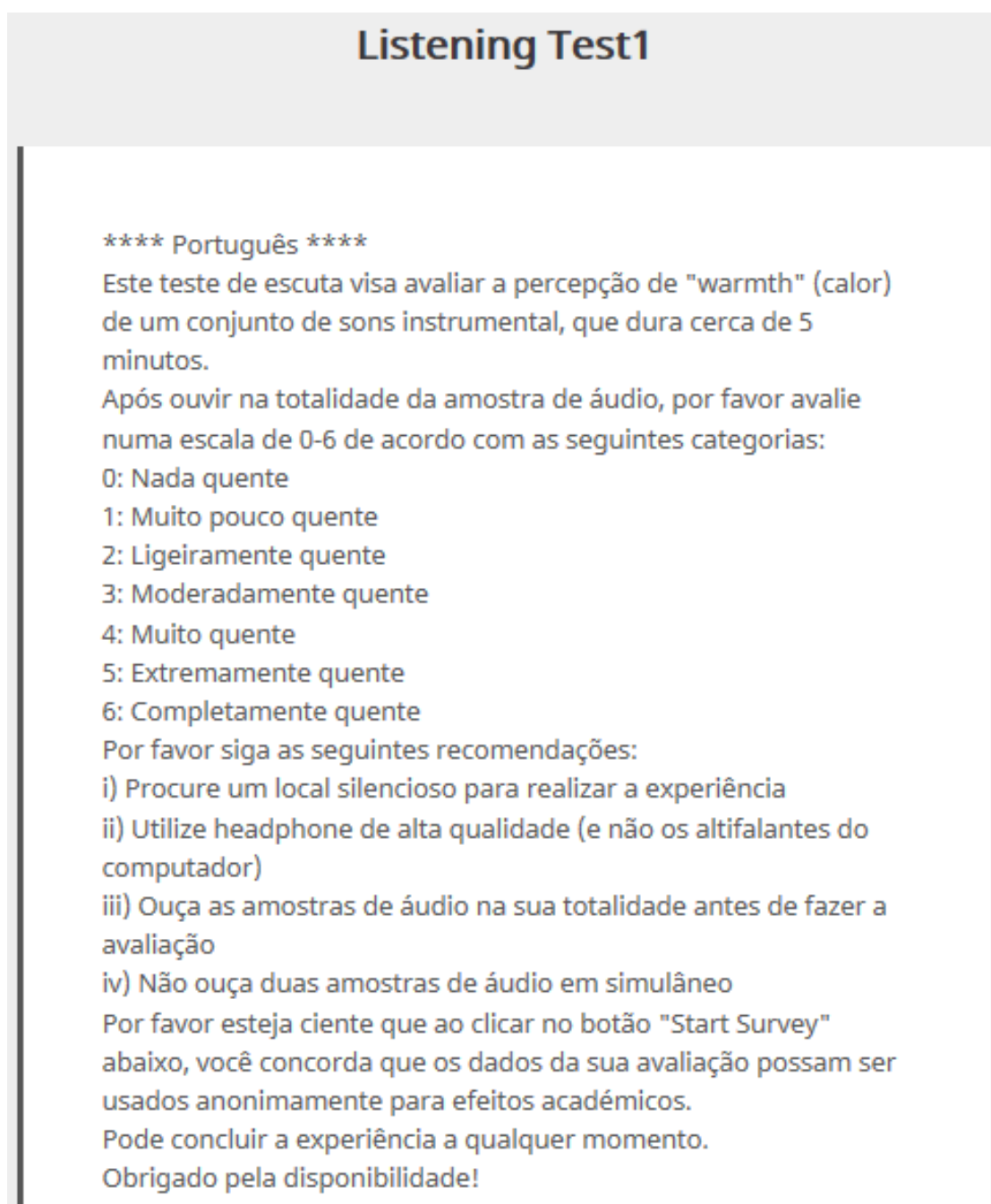

Figure A.6: Pure Data patch relative to the creation of an array with the first three harmonics of the signal

## A.2 Print screens and charts of the 1st listening test



**Listening Test1**

\*\*\*\* Português \*\*\*\*

Este teste de escuta visa avaliar a percepção de "warmth" (calor) de um conjunto de sons instrumental, que dura cerca de 5 minutos.

Após ouvir na totalidade da amostra de áudio, por favor avalie numa escala de 0-6 de acordo com as seguintes categorias:

0: Nada quente  
1: Muito pouco quente  
2: Ligeiramente quente  
3: Moderadamente quente  
4: Muito quente  
5: Extremamente quente  
6: Completamente quente

Por favor siga as seguintes recomendações:

- i) Procure um local silencioso para realizar a experiência
- ii) Utilize headphone de alta qualidade (e não os altifalantes do computador)
- iii) Ouça as amostras de áudio na sua totalidade antes de fazer a avaliação
- iv) Não ouça duas amostras de áudio em simultâneo

Por favor esteja ciente que ao clicar no botão "Start Survey" abaixo, você concorda que os dados da sua avaliação possam ser usados anonimamente para efeitos académicos.

Pode concluir a experiência a qualquer momento.

Obrigado pela disponibilidade!

.....

Figure A.7: Listening Test 1 - instructions, in portuguese, of how to answer the first listening

\*\*\*\* English\*\*\*\*

This listening test aims to evaluate the perceptual warmness of a collection of instrumental sounds and last for about 5 minutes. After listening to the entire duration of each audio sample, please rate it on a scale of 0-6 according to the following categories:

0: Not warm at all  
1: Very slightly warm  
2: Slightly warm  
3: Moderately warm  
4: Very warm  
5: Extremely warm  
6: Completely warm

Please follow these recommendations:

- i) find a quiet place to take the experiment;
- ii) use high quality headphones (not laptop speakers);
- iii) listen to the entire duration of the samples before rating;
- iv) do not play audio samples simultaneously.

Please be aware that by clicking the "Start Survey" button below, you agree that your rating data will be used anonymously for academic purposes.

You may stop the experiment at any time.

Thank you for your time!

**Start Survey**

Figure A.8: Listening Test 1 - instructions, in English, of how to answer the first listening

**Q.1** **Selecione uma das opções abaixo dependendo do seu nível de experiência musical | Select one of the options below depending on your level of musical expertise \***

Eu tenho muita experiência em produção, criação e execução musical | I have high expertise in music production, creation and performance

Eu tenho alguma experiência em produção, criação e execução musical | I have some expertise in music production, creation and performance

Não tenho qualquer experiência em produção, criação e execução musical | I have no expertise in music production, creation and performance

**Q.2** **Idade | Age \***

**Q.3** **Sexo | Gender \***

Masculino | Male

Feminino | Female

**Q.4** **Finalmente, verifique o volume do seu dispositivo usando a amostra de teste abaixo. | Finally, verify the volume of your device using the test sample below.**



**Continue**

Figure A.9: Listening Test 1 - characterization of the participant

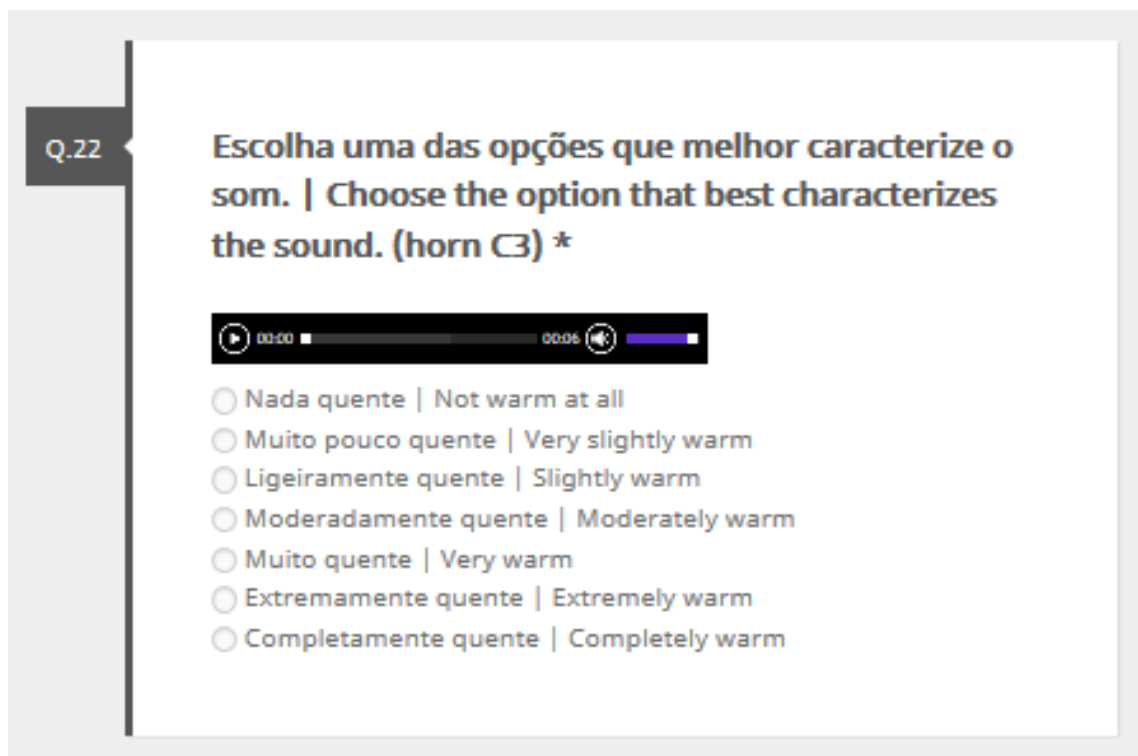

Figure A.10: Listening Test 1 - example of question where the participant has to evaluate the sound according to the categories. This same type of question was done for all the sample chosen in Table 3.1.

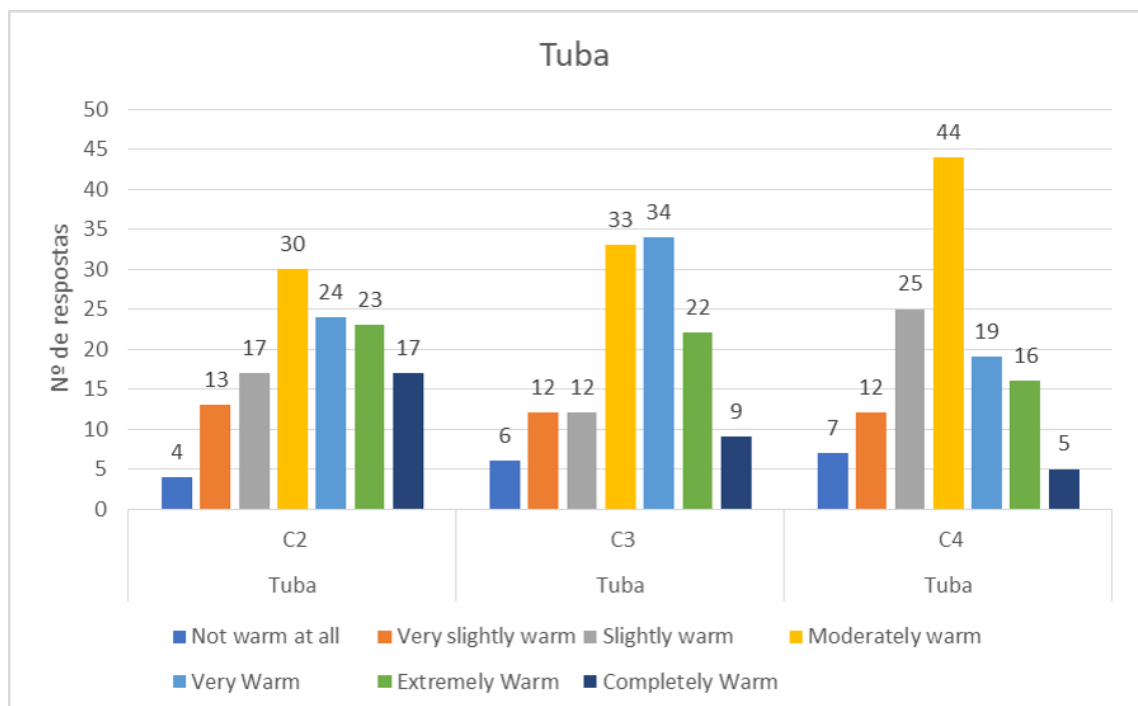

Figure A.11: Response chart for all three tuba examples

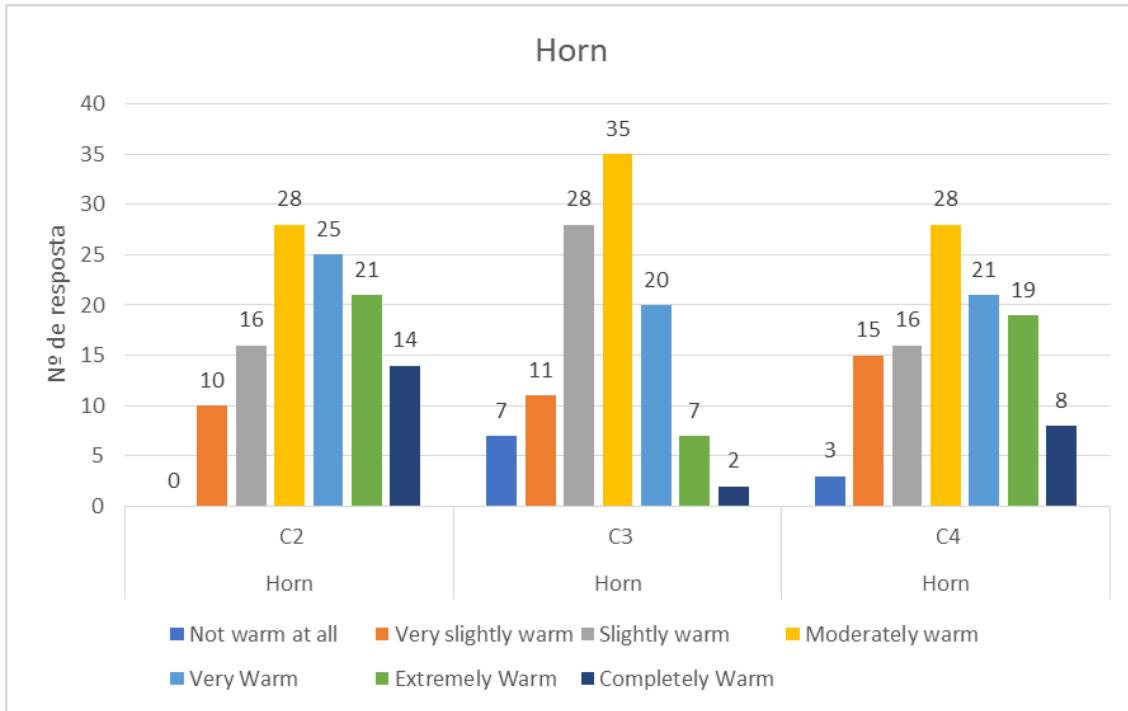

Figure A.12: Response chart for all three horn examples

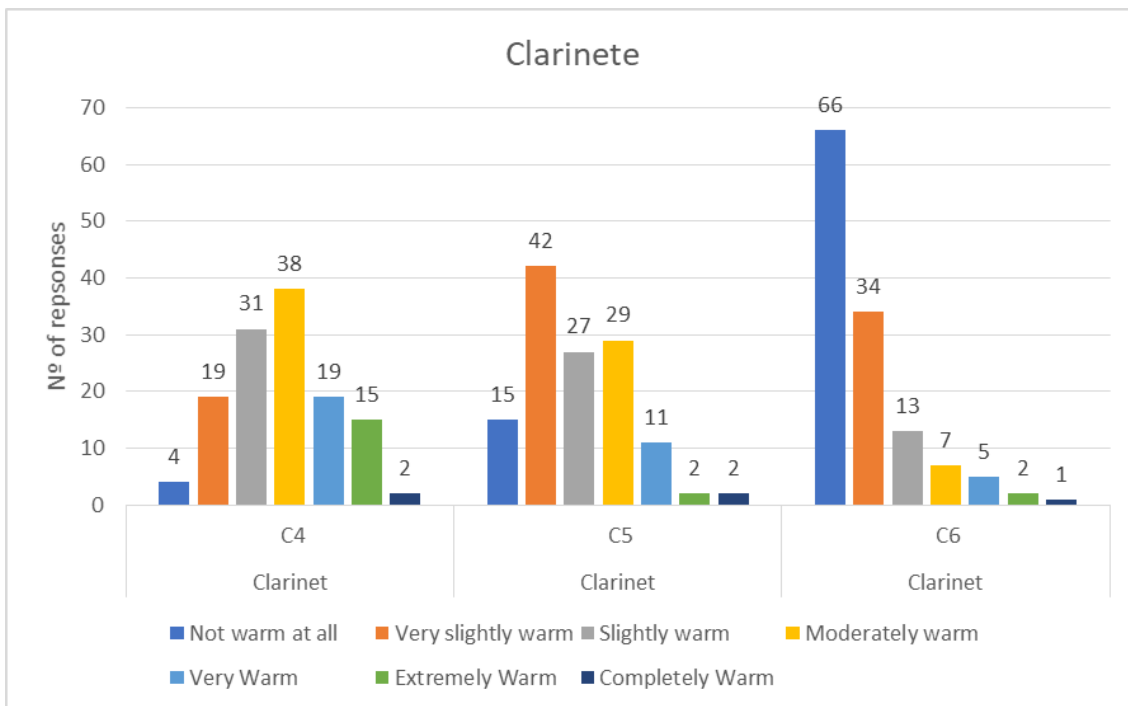

Figure A.13: Response chart for all three clarinet examples

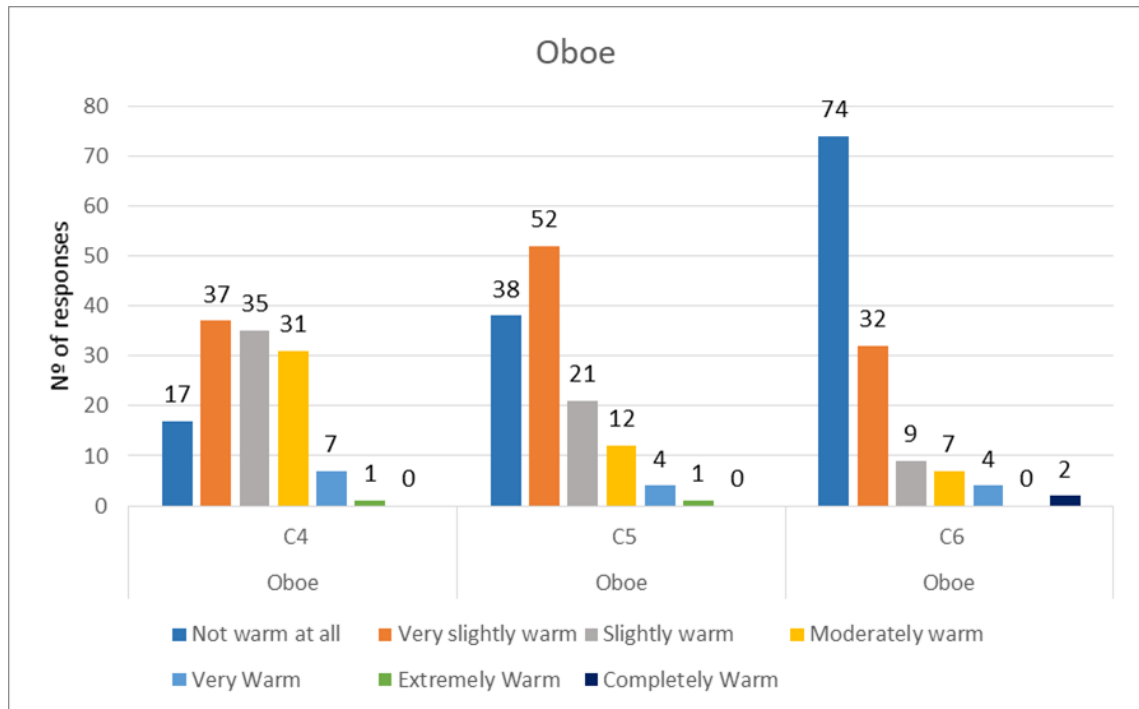

Figure A.14: Response chart for all three oboe examples

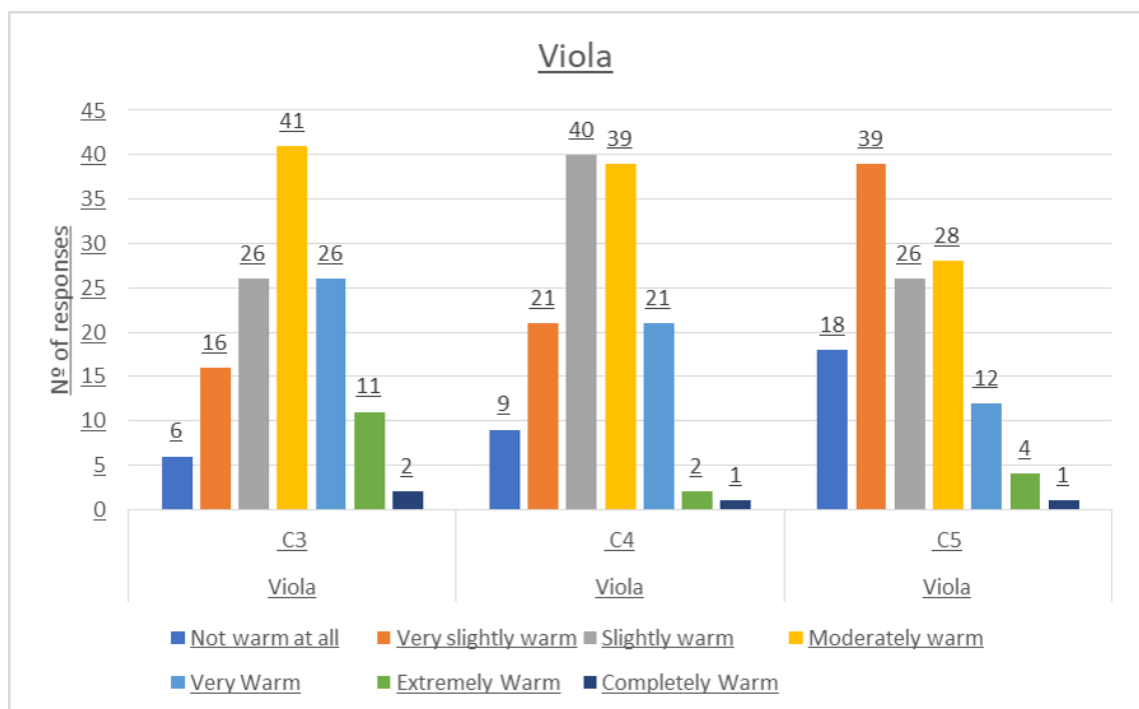

Figure A.15: Response chart for all three viola examples

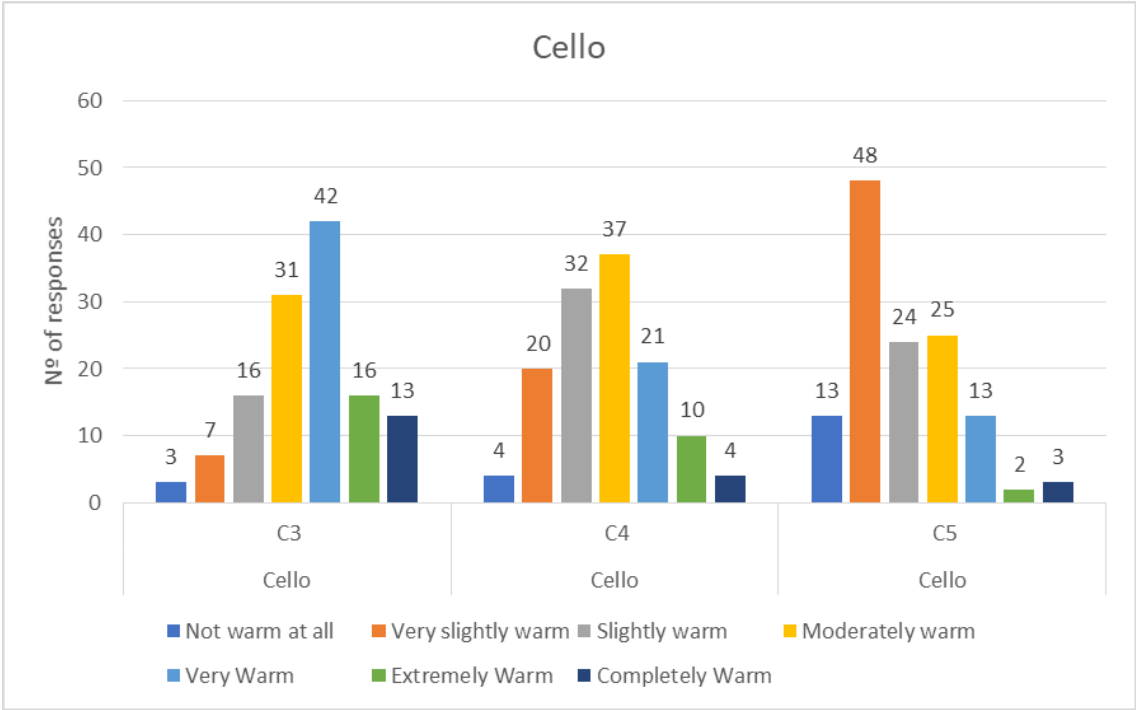

Figure A.16: Response chart for all three violoncello examples

### A.3 Matlab plots of the results of the first listening test

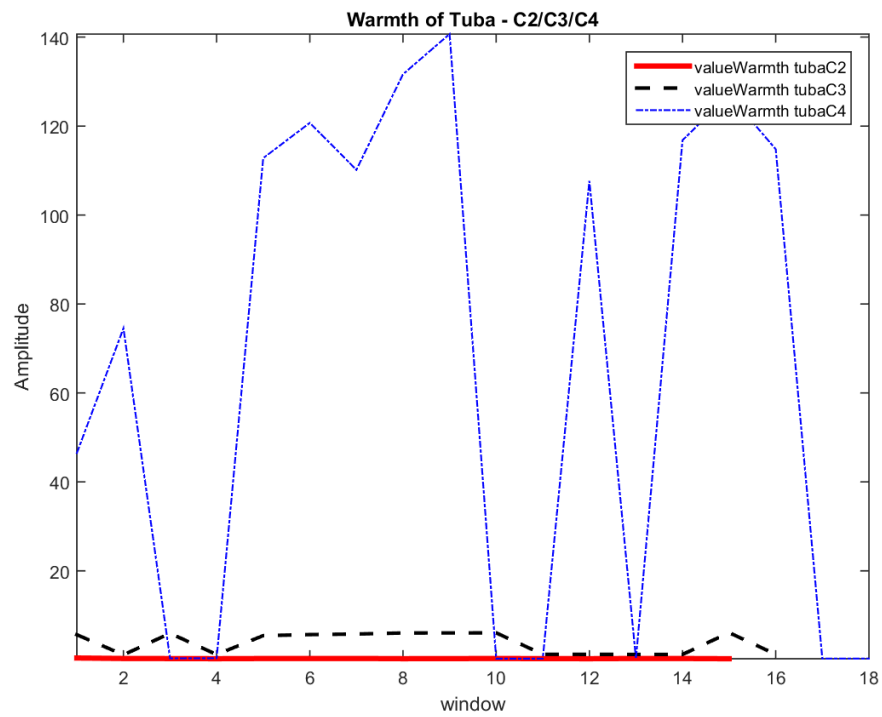

Figure A.17: Variation of the value of warmth in each audio file

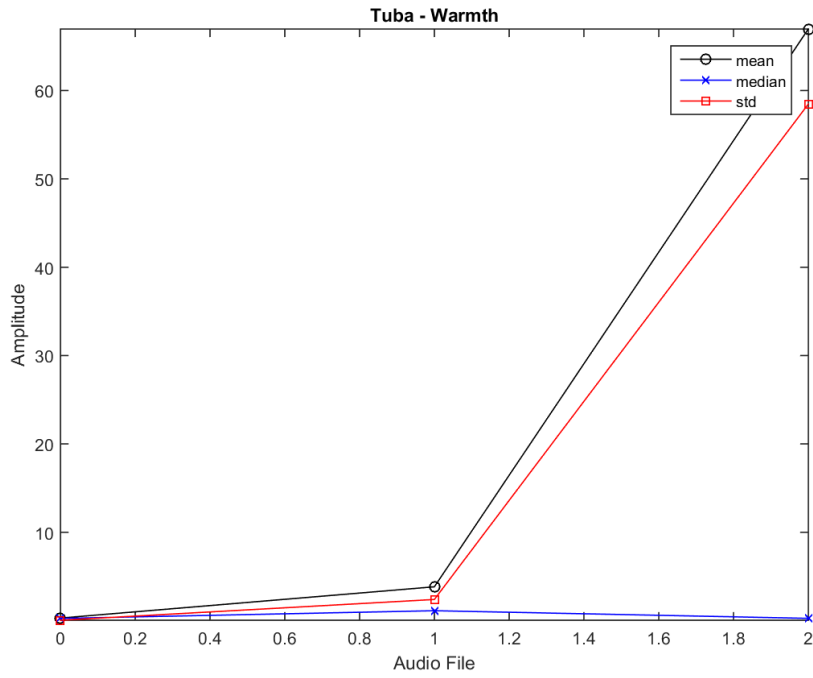

Figure A.18: Mean median and standard deviation of warmth in the three tuba sound examples. The leftmost (at '0') values belong to the sound of tuba C2. The values at '1' belongs to the sound of tuba C3 and the rightmost (at '2') values belong to the sound of tuba C4

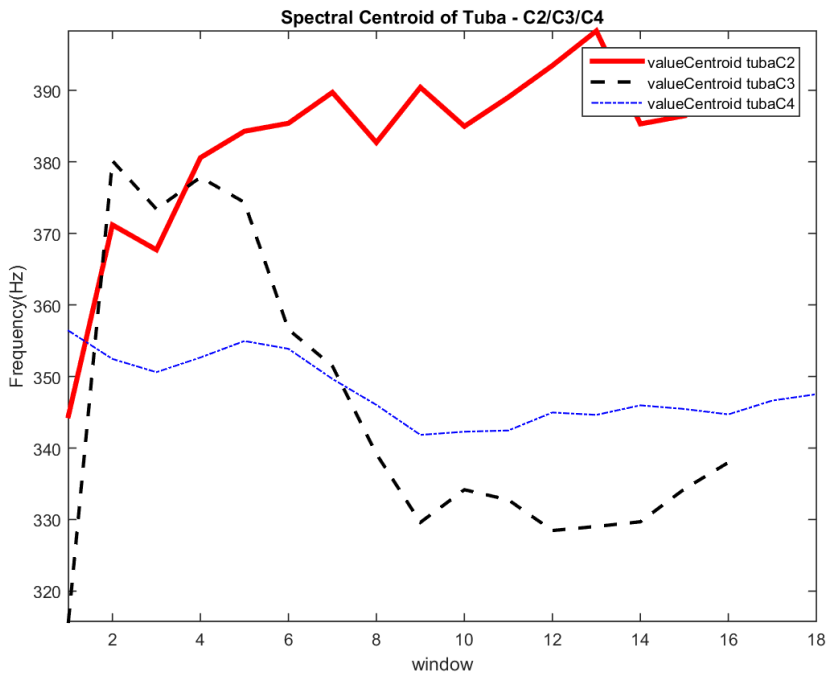

Figure A.19: Variation of the value of the spectral centroid in each audio file

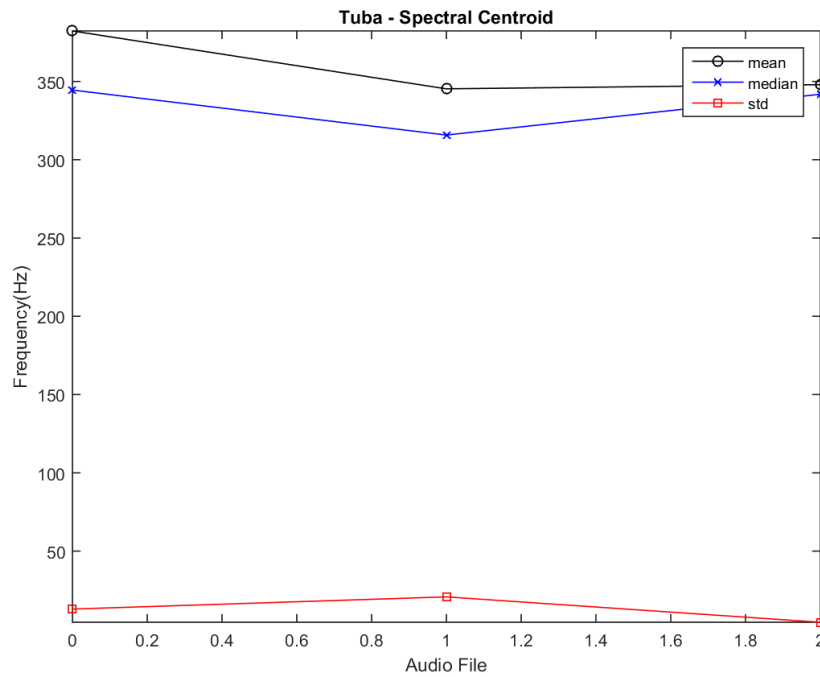

Figure A.20: Mean median and standard deviation of the spectral centroid in the three tuba sound examples. The leftmost (at '0') values belong to the sound tuba C2. The values at '1' belong to the sound of tuba C3 and the rightmost (at '2') values belong to the sound of tuba C4

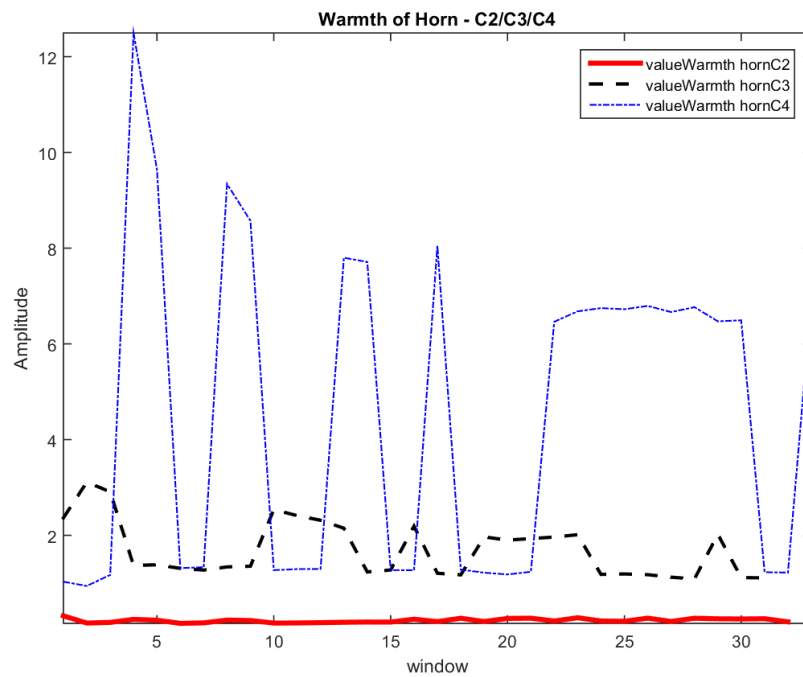

Figure A.21: Variation of the value of warmth in each audio file

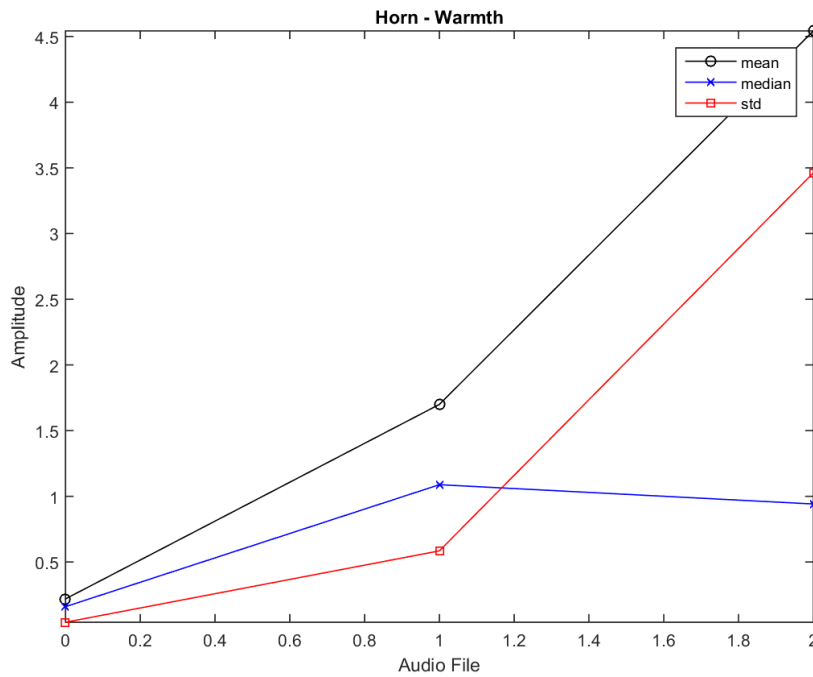

Figure A.22: Mean median and standard deviation of warmth in the three horn sound examples. The leftmost (at '0') values belong to the sound of horn C2. The values at '1' belongs to the sound of horn C3 and the rightmost (at '2') values belong to the sound of horn C4

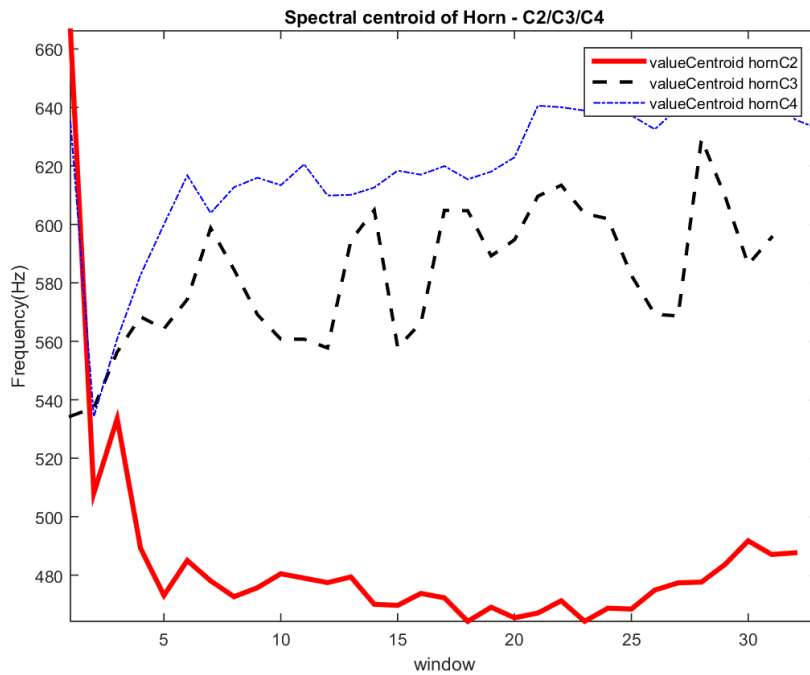

Figure A.23: Variation of the value of the spectral centroid in each audio file.

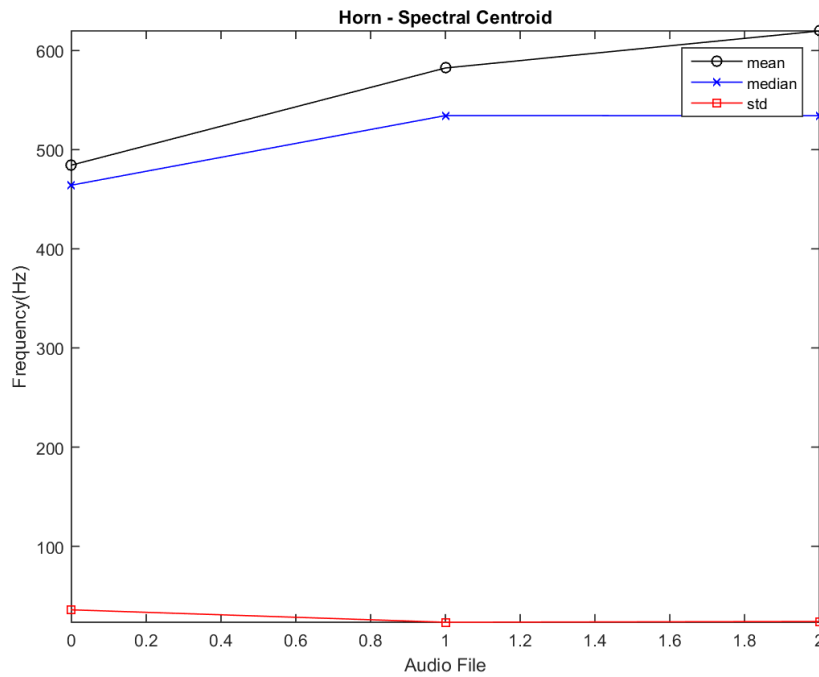

Figure A.24: Mean median and standard deviation of the spectral centroid in the three horn sound examples. The leftmost (at '0') values belong to the sound horn C2. The values at '1' belong to the sound of horn C3 and the rightmost (at '2') values belong to the sound of horn C4

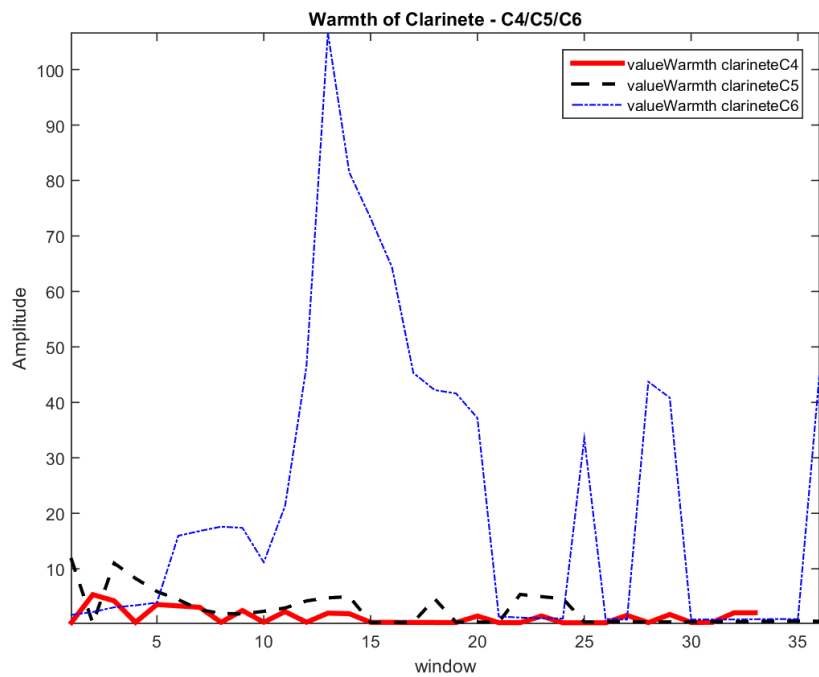

Figure A.25: Variation of the value of warmth in each audio file

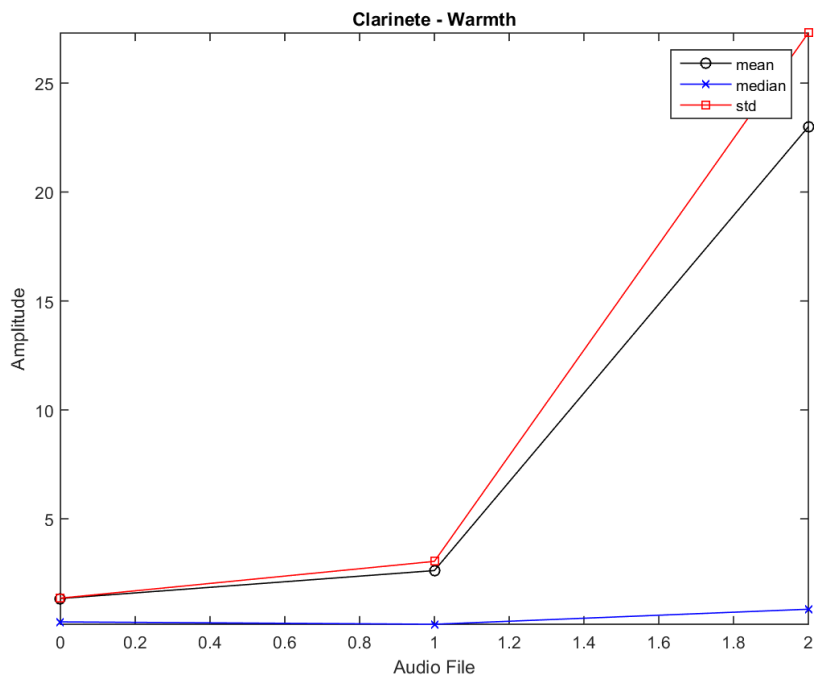

Figure A.26: Mean median and standard deviation of warmth in the three clarinet sound examples. The leftmost (at '0') values belong to the sound of clarinet C4. The values at '1' belongs to the sound of clarinet C5 and the rightmost (at '2') values belong to the sound of clarinet C6

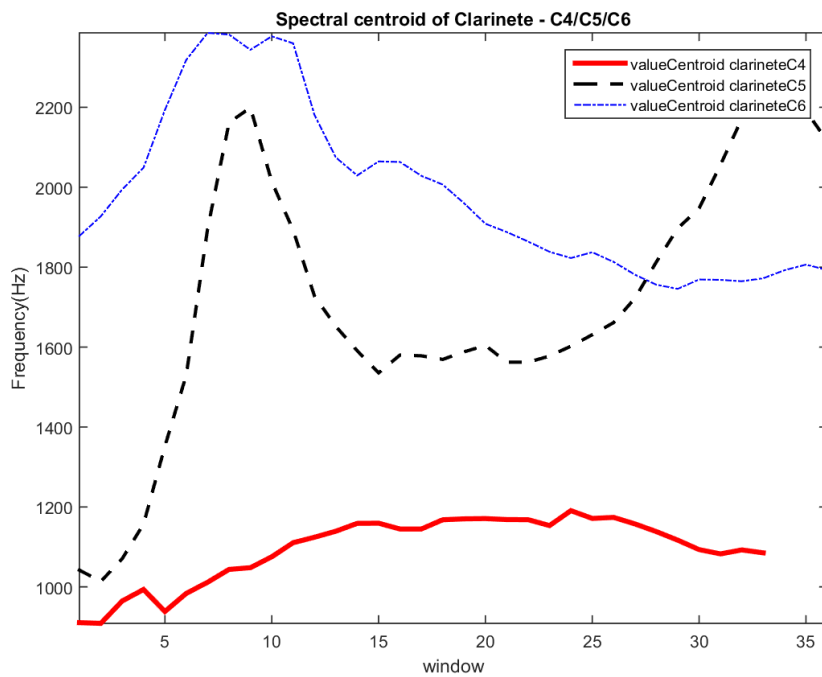

Figure A.27: Variation of the value of the spectral centroid in each audio file

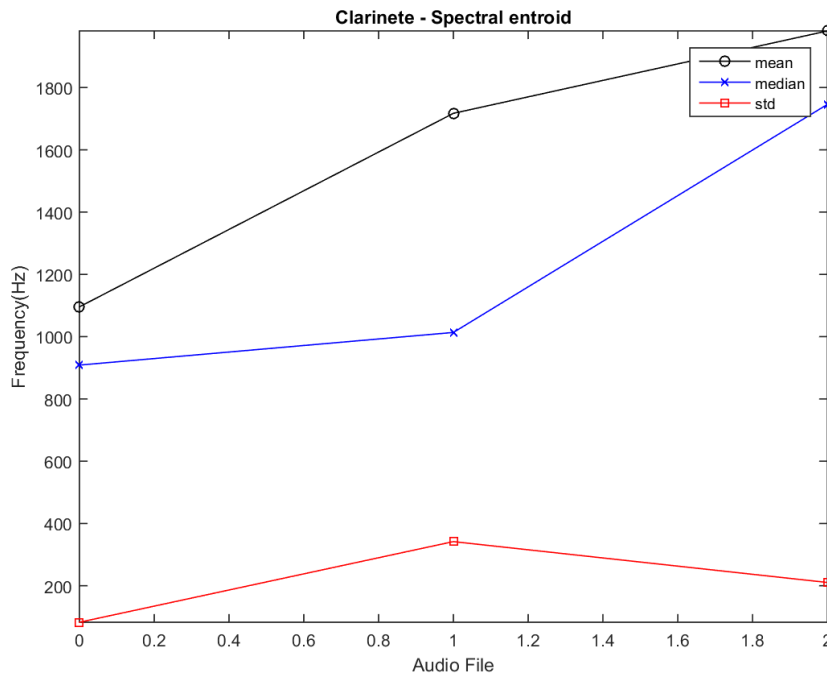

Figure A.28: Mean median and standard deviation of the spectral centroid in the three clarinet sound examples. The leftmost (at '0') values belong to the sound of clarinet C4. The values at '1' belongs to the sound of clarinet C5 and the rightmost (at '2') values belong to the sound of clarinet C6

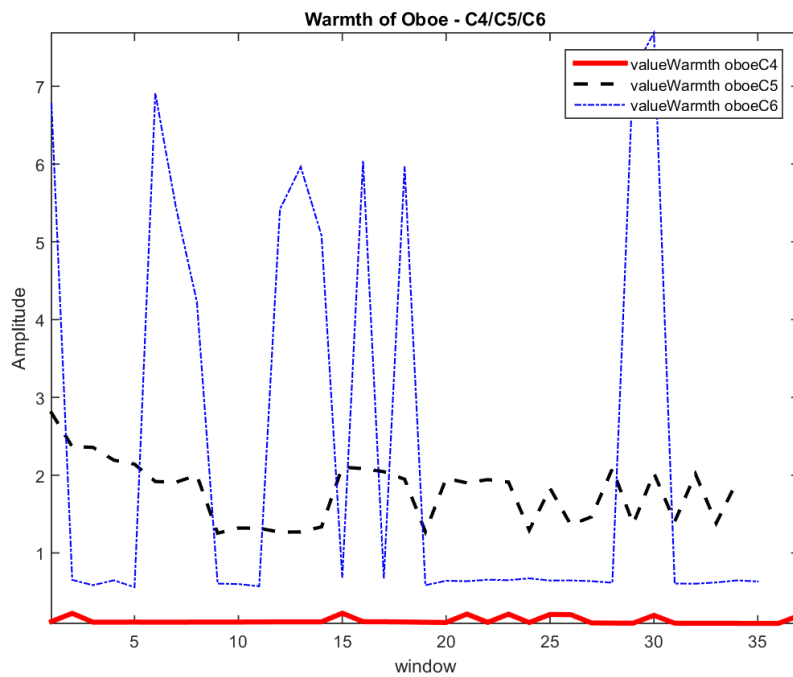

Figure A.29: Variation of the value of warmth in each audio file

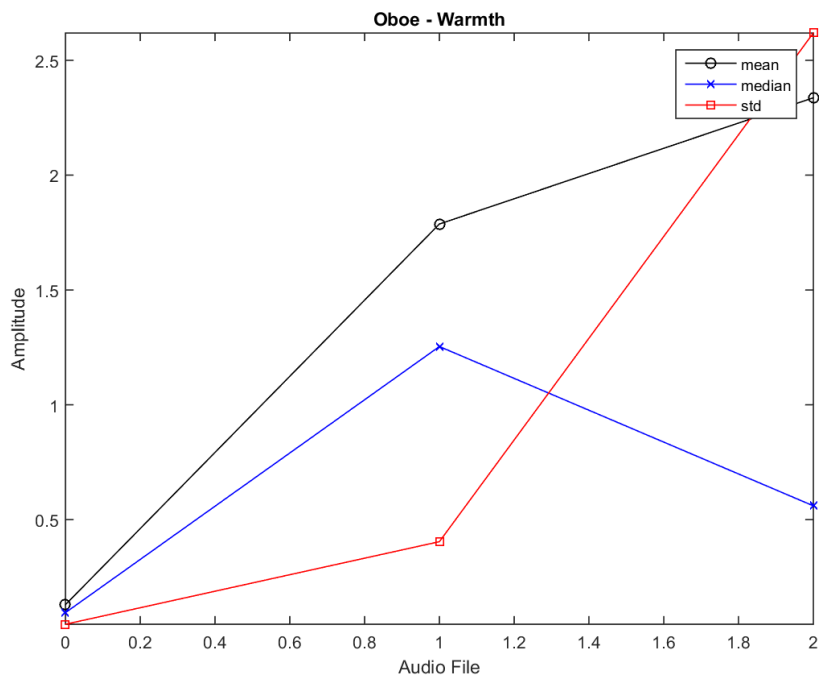

Figure A.30: Mean median and standard deviation of warmth in the three oboe sound examples. The leftmost (at '0') values belong to the sound of oboe C4. The values at '1' belongs to the sound of oboe C5 and the rightmost (at '2') values belong to the sound of oboe C6

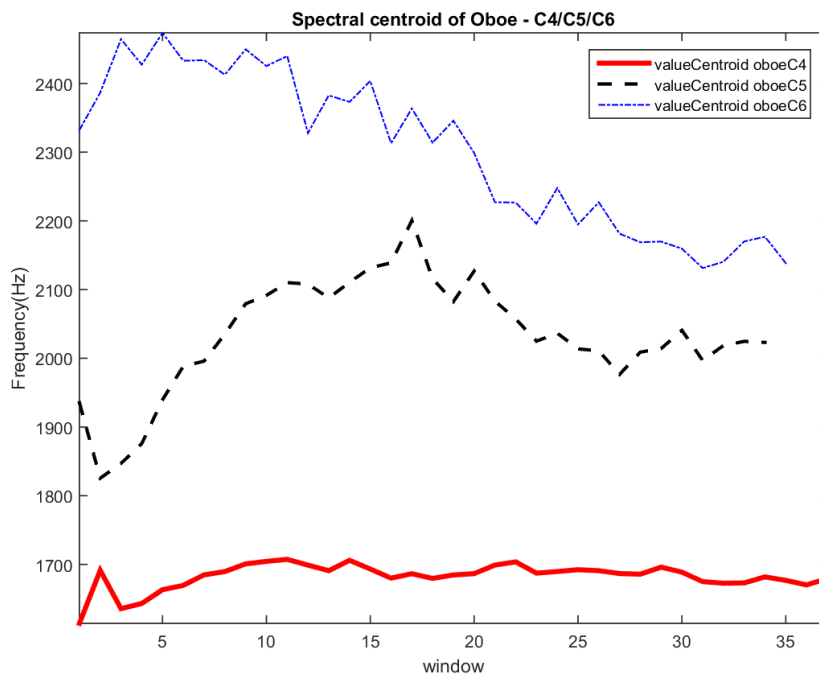

Figure A.31: Variation of the value of the spectral centroid in each audio file

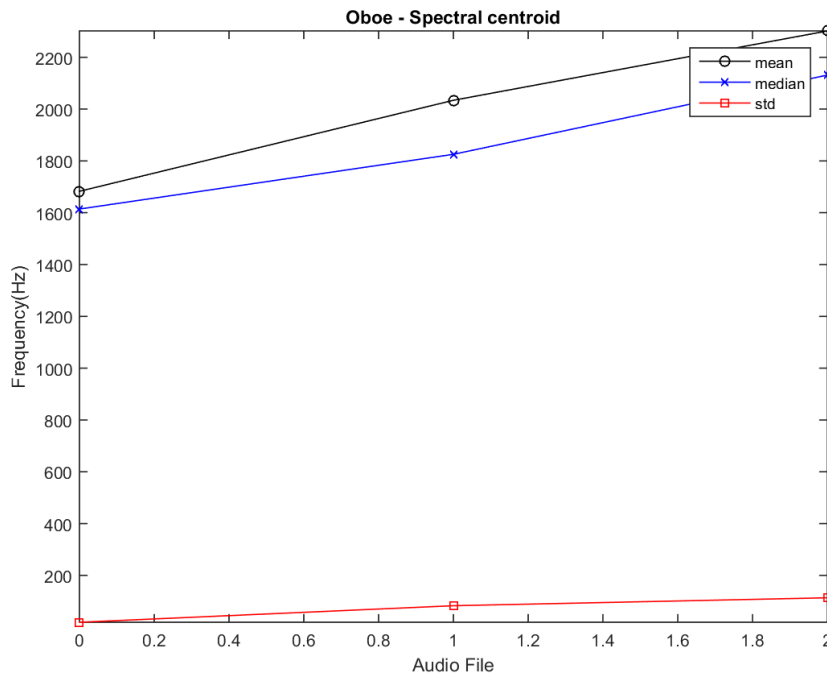

Figure A.32: Mean median and standard deviation of the spectral centroid in the three oboe sound examples. The leftmost (at '0') values belong to the sound of oboe C4. The values at '1' belongs to the sound of oboe C5 and the rightmost (at '2') values belong to the sound of oboe C6

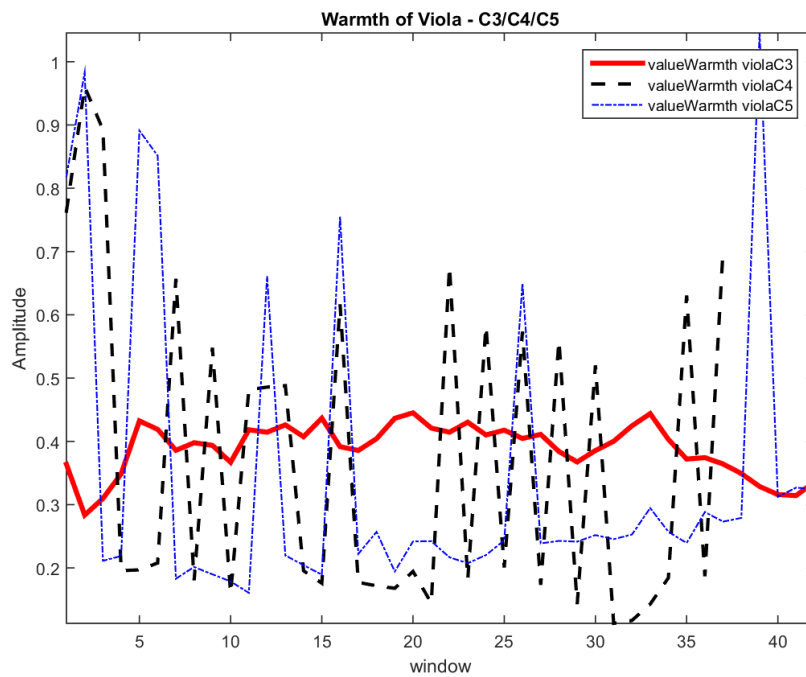

Figure A.33: Variation of the value of warmth in each audio file

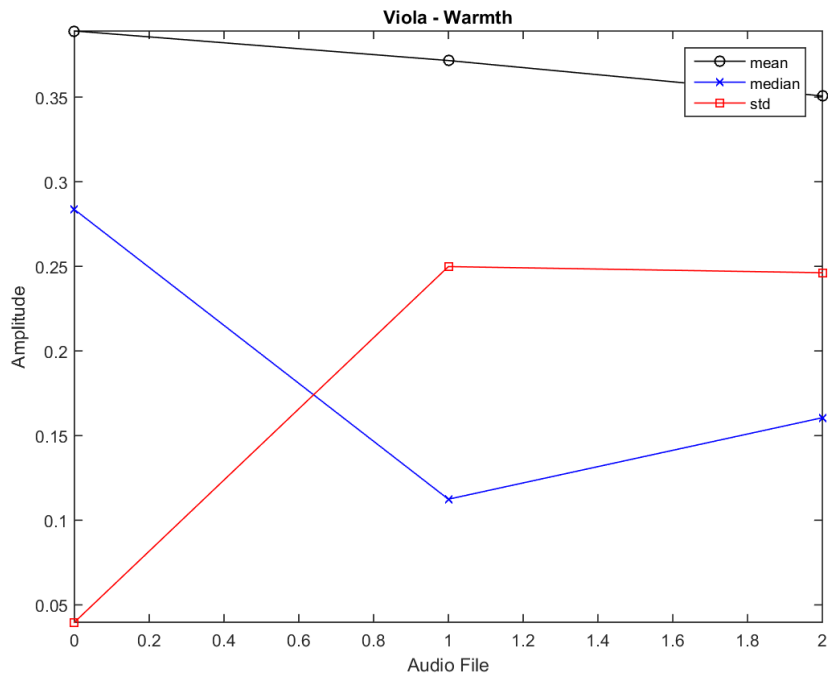

Figure A.34: Mean median and standard deviation of warmth in the three viola sound examples. The leftmost (at '0') values belong to the sound of viola C3. The values at '1' belongs to the sound of viola C4 and the rightmost (at '2') values belong to the sound of viola C5

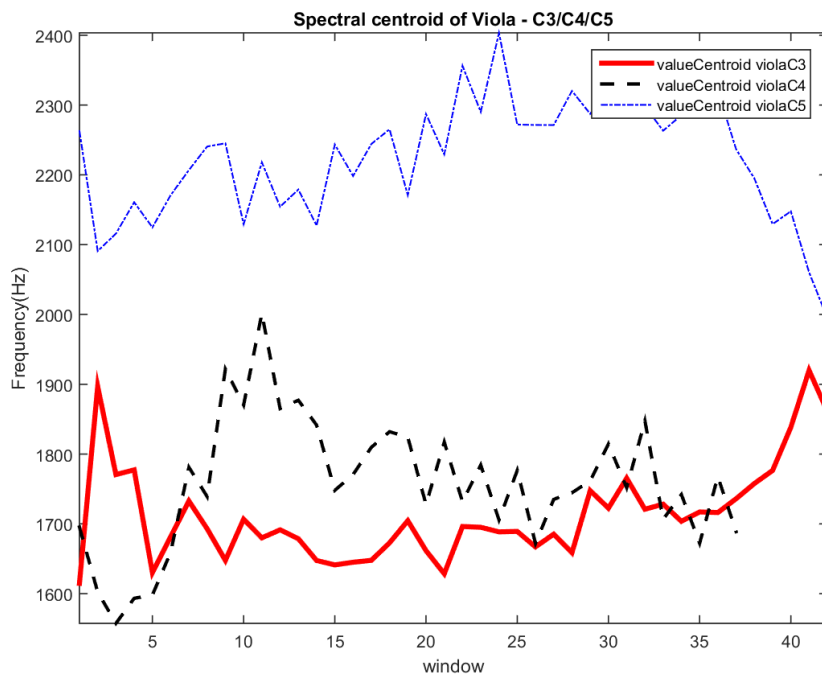

Figure A.35: Variation of the value of the spectral centroid in each audio file

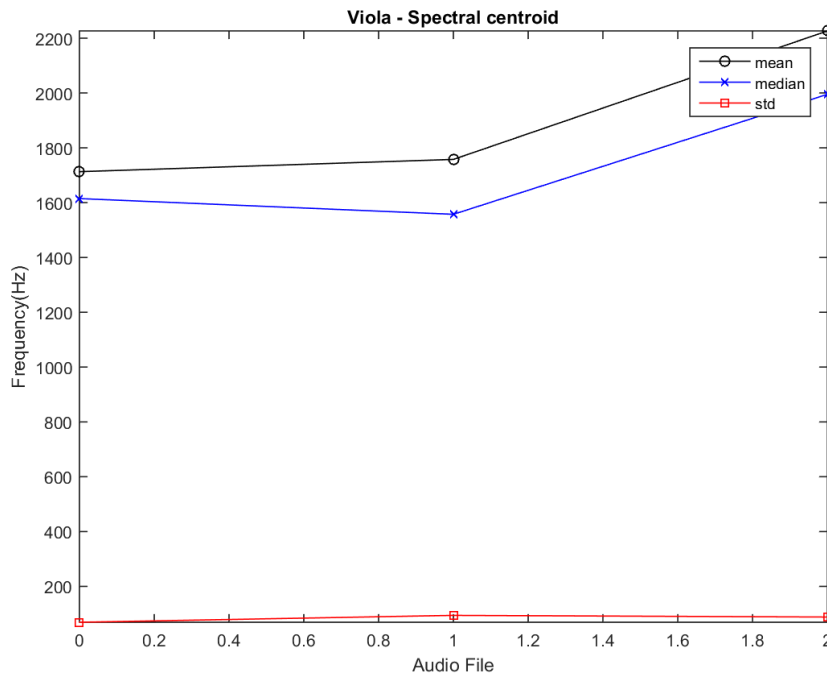

Figure A.36: Mean median and standard deviation of the spectral centroid in the three viola sound examples. The leftmost (at '0') values belong to the sound of viola C3. The values at '1' belongs to the sound of viola C4 and the rightmost (at '2') values belong to the sound of viola C5

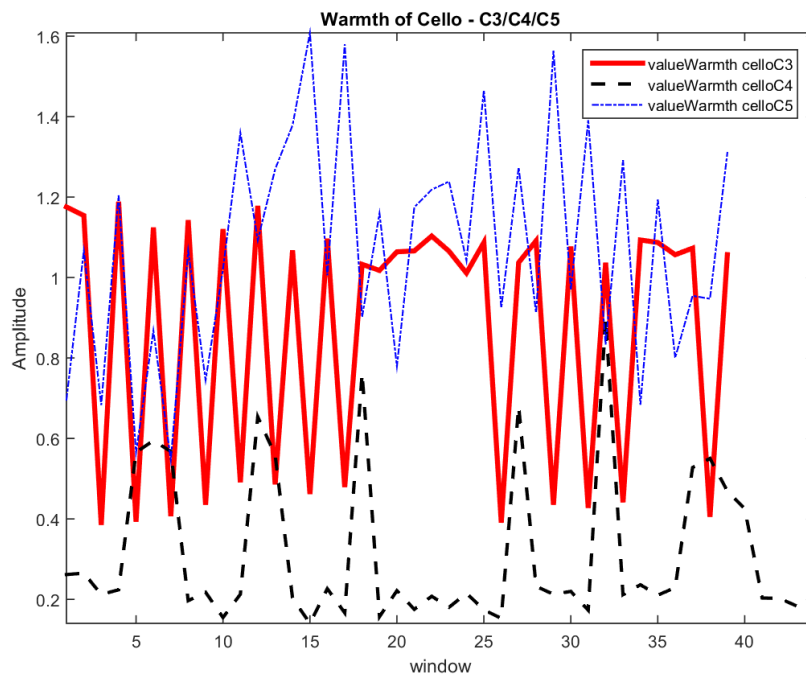

Figure A.37: Variation of the value of warmth in each audio file

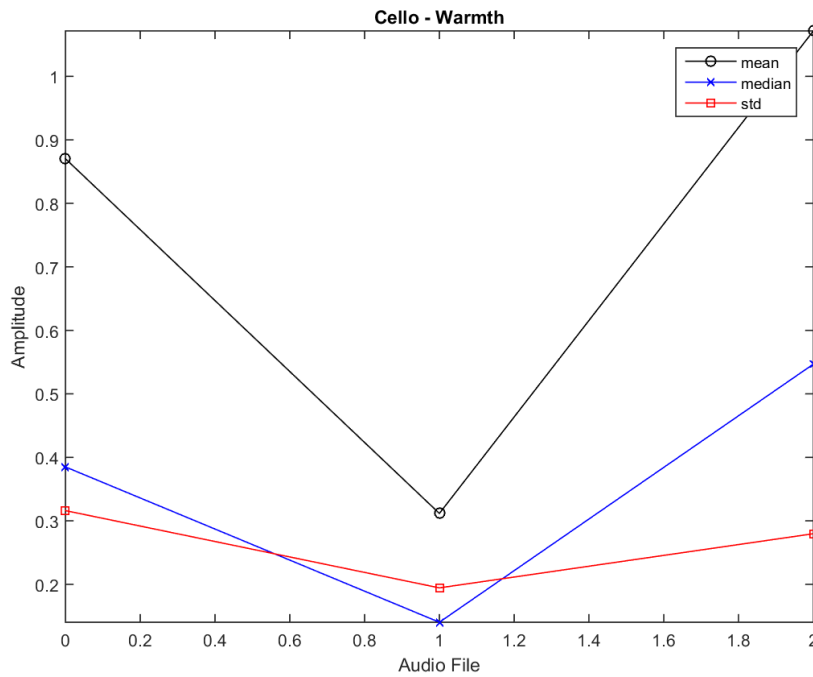

Figure A.38: Mean median and standard deviation of warmth in the three violoncello sound examples. The leftmost (at '0') values belong to the sound of violoncello C3. The values at '1' belong to the sound of violoncello C4 and the rightmost (at '2') values belong to the sound of violoncello C5

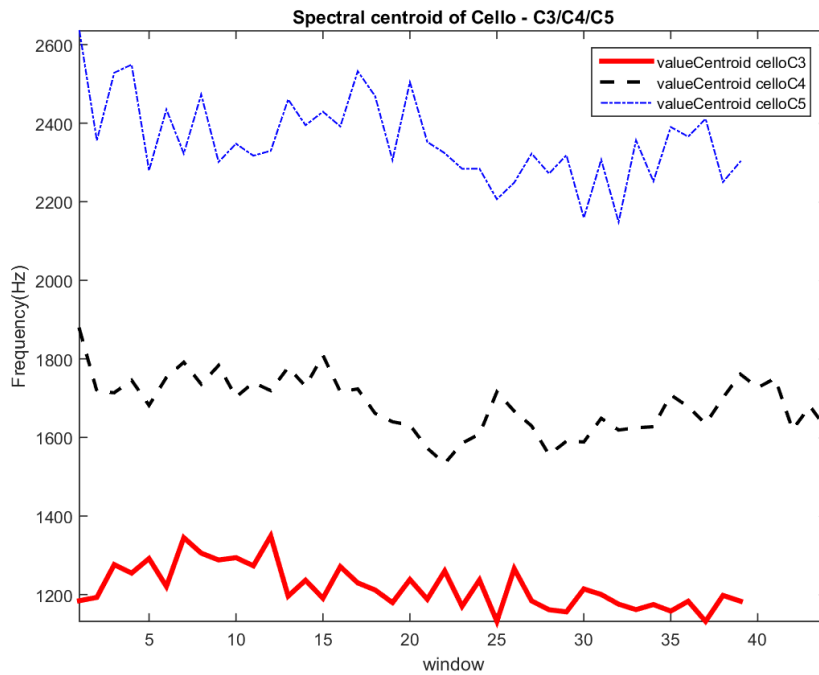

Figure A.39: Variation of the value of the spectral centroid in each audio file

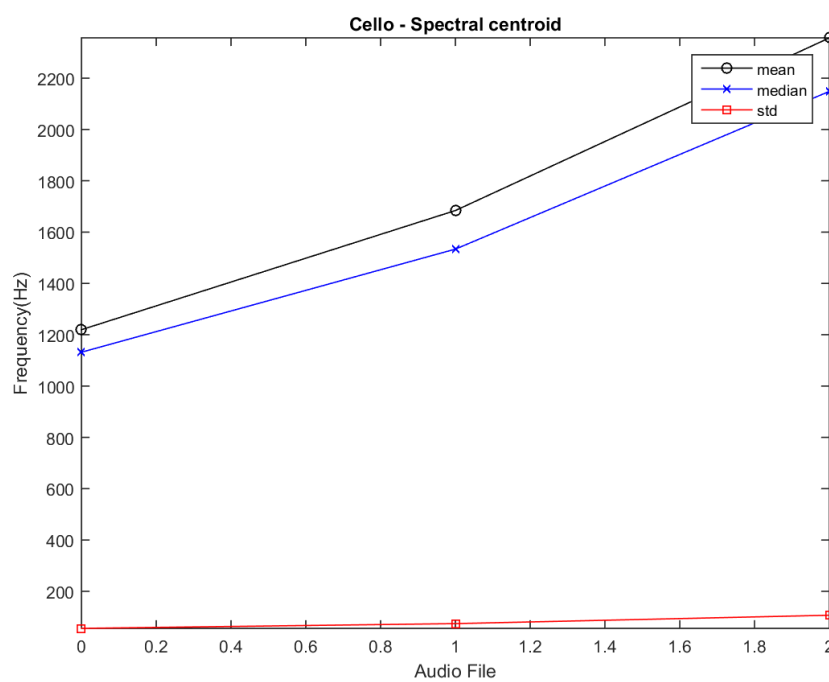

Figure A.40: Mean median and standard deviation of the spectral centroid in the three violoncello sound examples. The leftmost (at '0') values belong to the sound of violoncello C3. The values at '1' belong to the sound of violoncello C4 and the rightmost (at '2') values belong to the sound of violoncello C5

## A.4 Print screens charts and plots relative to the second listening test

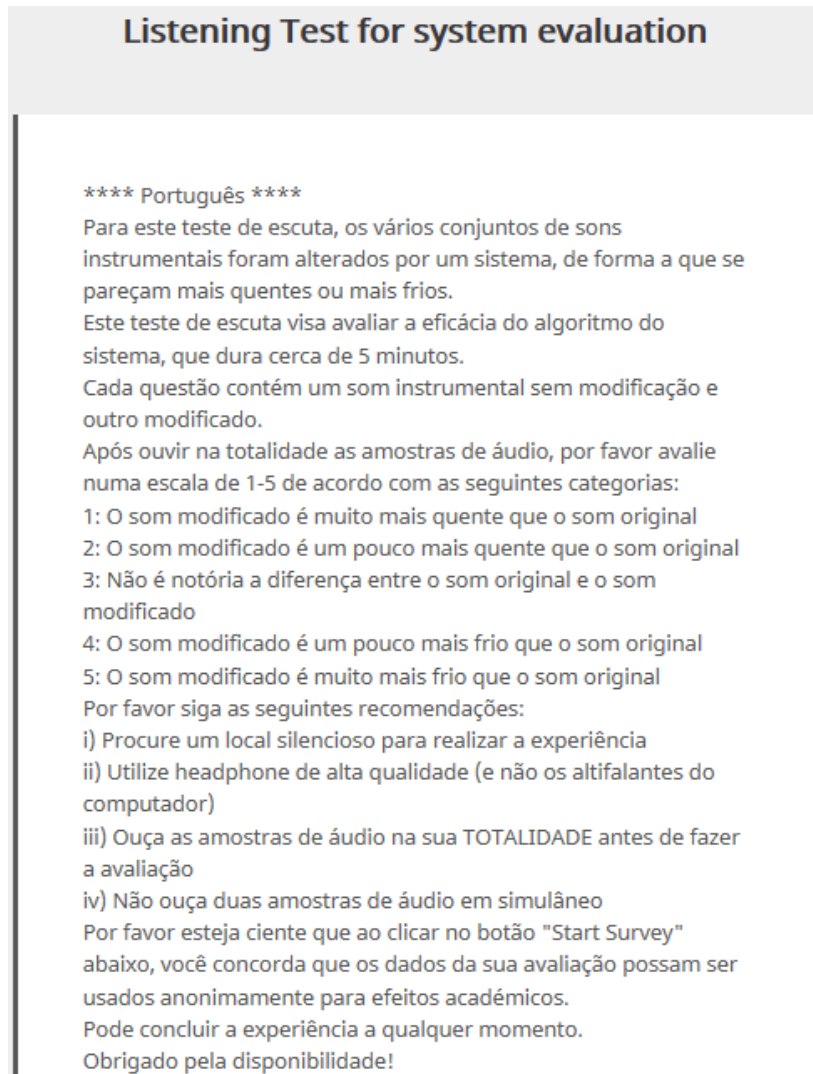

Figure A.41: Listening Test 2 - instructions, in portuguese, of how to answer the first listening

\*\*\*\* English\*\*\*\*

For this listening test, a collection of instrumental sounds were modified by a system, in order to sound warmer or colder. This listening test aims to evaluate the efficiency of the system's algorithm and takes about 5 minutes.

Each question has the original instrumental sound (without modification) and the same sound, but modified.

After listening to the entire duration of each audio sample, please rate it on a scale of 1-5 according to the following categories:

1: The modified sound is much more warmer than the original sound

2: The modified sound is a bit more warmer than the original sound

3: There is not much difference between the two sounds

4: The modified sound is much more colder than the original sound

5: The modified sound is a bit more colder than the original sound

Please follow these recommendations:

- i) find a quiet place to take the experiment;
- ii) use high quality headphones (not laptop speakers);
- iii) listen to the ENTIRE duration of the samples before rating;
- iv) do not play audio samples simultaneously.

Please be aware that by clicking the "Start Survey" button below, you agree that your rating data will be used anonymously for academic purposes.

You may stop the experiment at any time.

Thank you for your time!

**Start Survey**

Figure A.42: Listening Test 2 - instructions, in english, of how to answer the first listening

**Selecione uma das opções abaixo dependendo do seu nível de experiência musical | Select one of the options below depending on your level of musical expertise \***

Eu tenho muita experiência em produção, criação e execução musical | I have high expertise in music production, creation and performance

Eu tenho alguma experiência em produção, criação e execução musical | I have some expertise in music production, creation and performance

Não tenho qualquer experiência em produção, criação e execução musical | I have no expertise in music production, creation and performance

**Idade | Age \***

15-19

20-30

30-40

> 40

**Sexo | Gender \***

Masculinho | Male

Feminino | Female

**Finalmente, verifique o volume do seu dispositivo usando a amostra de teste abaixo. | Finally, verify the volume of your device using the test sample below.**

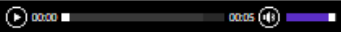

**Continue**

Figure A.43: Listening Test 2 - characterization of the individual

**Escolha uma das opções que melhor caracterize o som. | Choose the option that best characterizes the sound. (horn) \***

Som original | Original File:



Som modificado | Modified Sound:

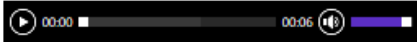

- O som modificado é muito mais quente que o som original | The modified sound is much more warmer than the original sound
- O som modificado é um pouco mais quente que o som original | The modified sound is a bit more warmer than the original sound
- Não é notória a diferença entre o som original e o som modificado | The is not much difference between the two sounds
- O som modificado é um pouco mais frio que o som original | The modified sound is much more colder than the original sound
- O som modificado é muito mais frio que o som original | The modified sound is a bit more colder than the original sound

Figure A.44: Listening Test 2 - example of question where the individual has to evaluate the modified sound taking into account the original audio file. Each modified sound could be equal to the original audio file, or with +25% or +50% warmth. This same type of question was done for all the audio file explained in Section 5.1.

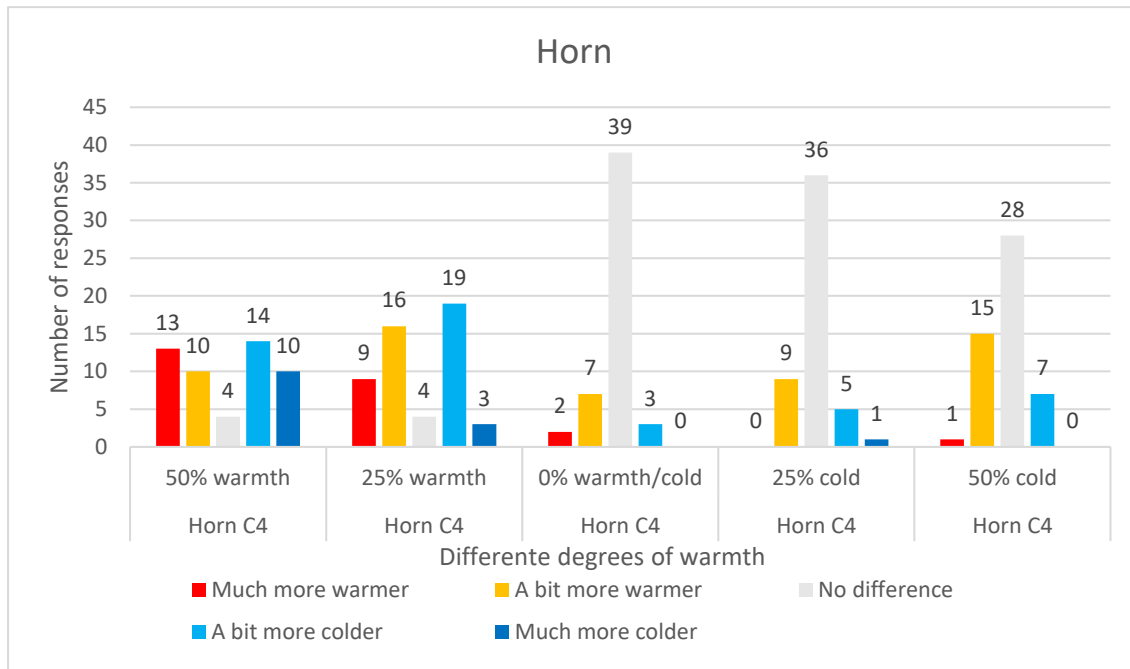

Figure A.45: Chart of the responses for all four transformation of horn C4

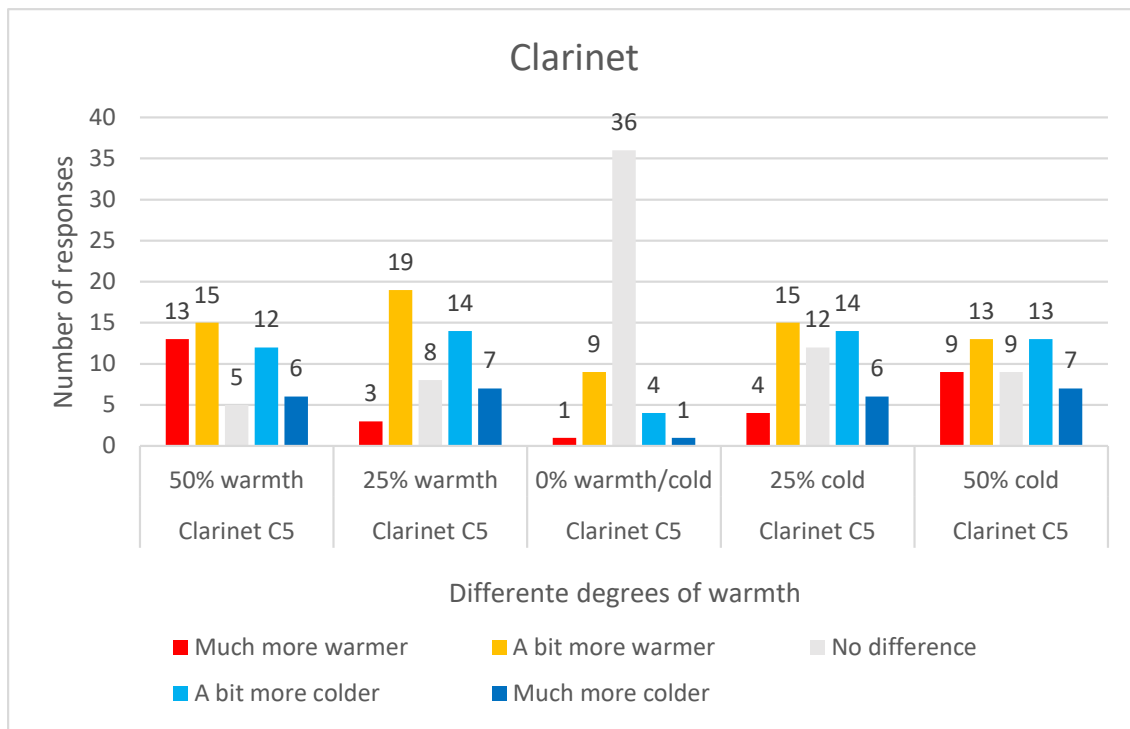

Figure A.46: Chart of the responses for all four transformation of clarinet C5

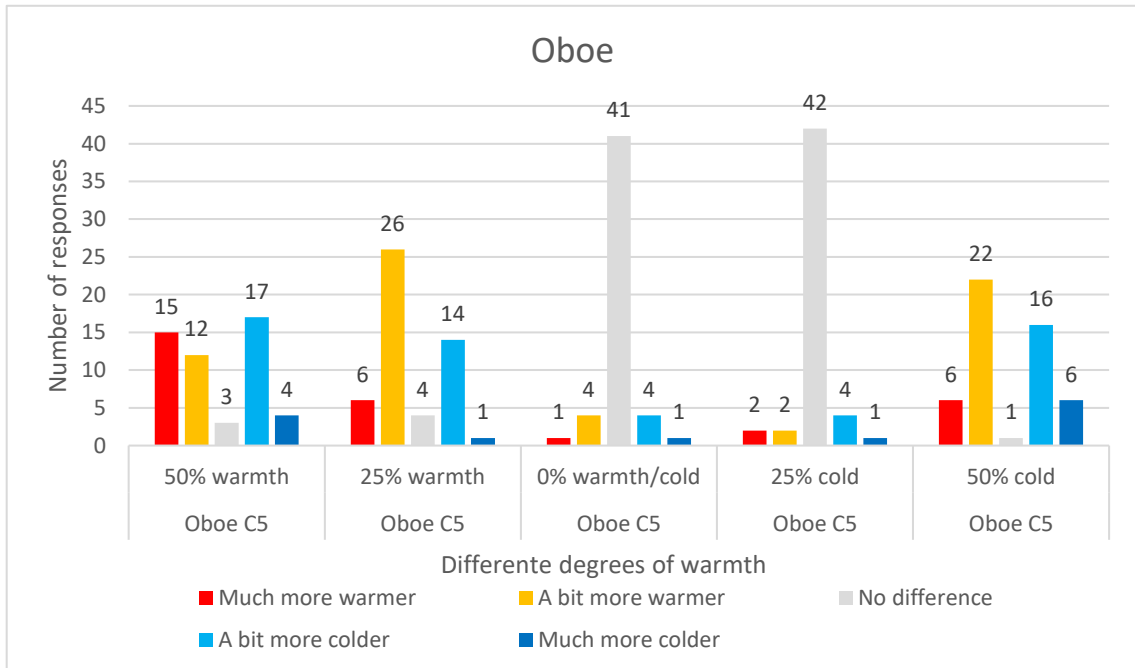

Figure A.47: Chart of the responses for all four transformation of oboe C5

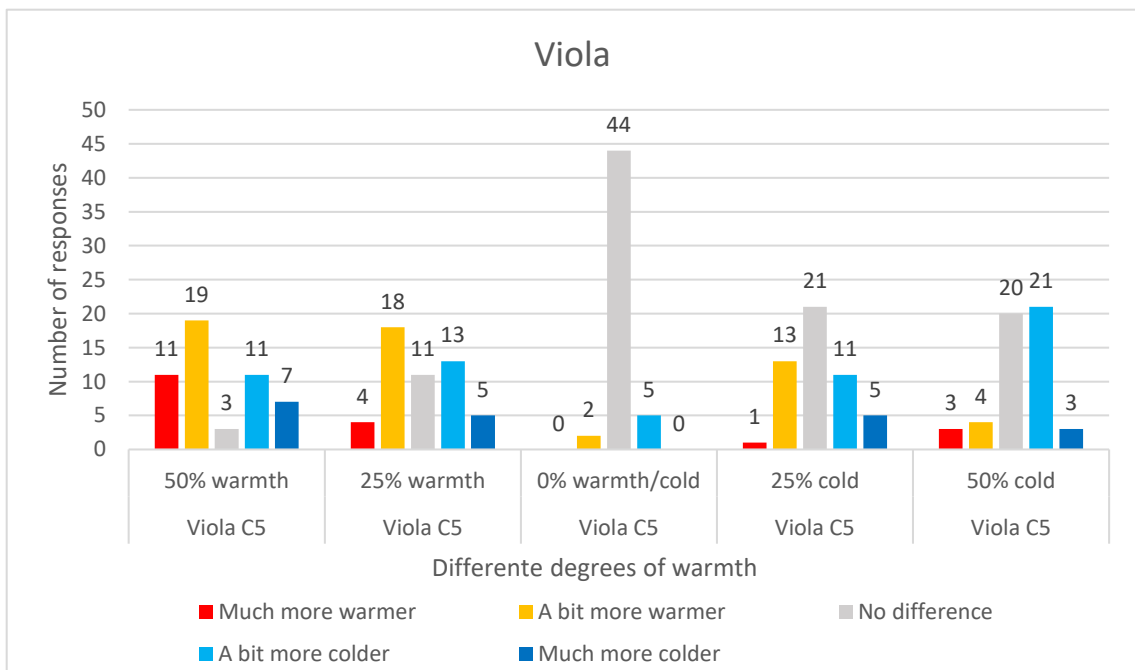

Figure A.48: Chart of the responses for all four transformation of viola C5

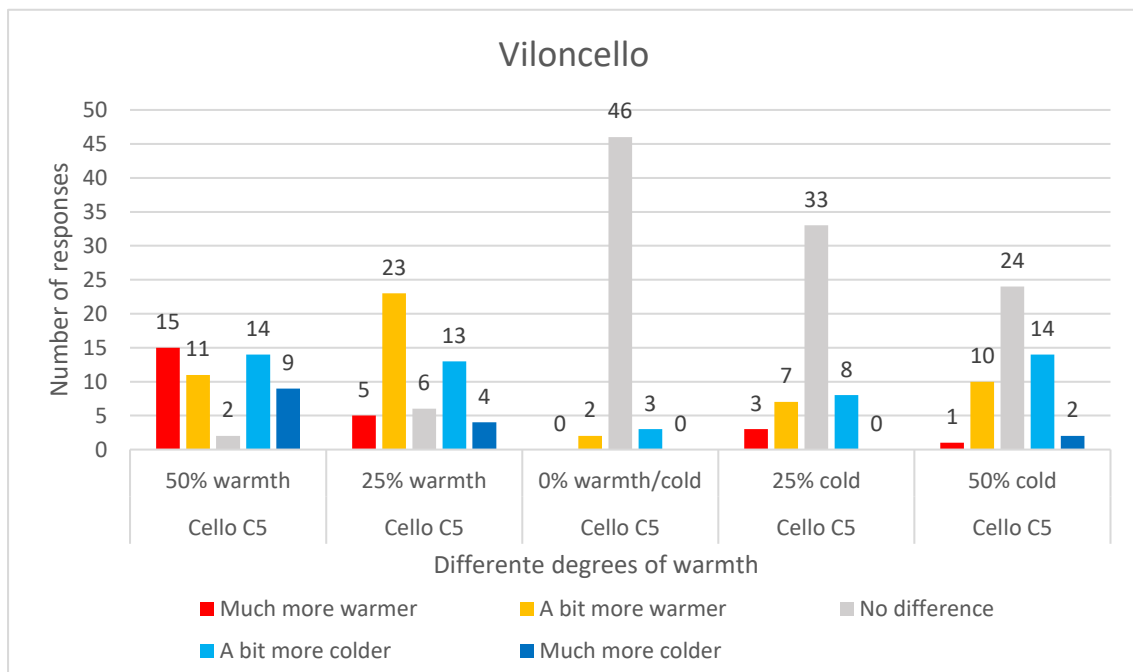

Figure A.49: Chart of the responses for all four transformation of violoncello C5

## A.5 Matlab plots of the results of the second listening test

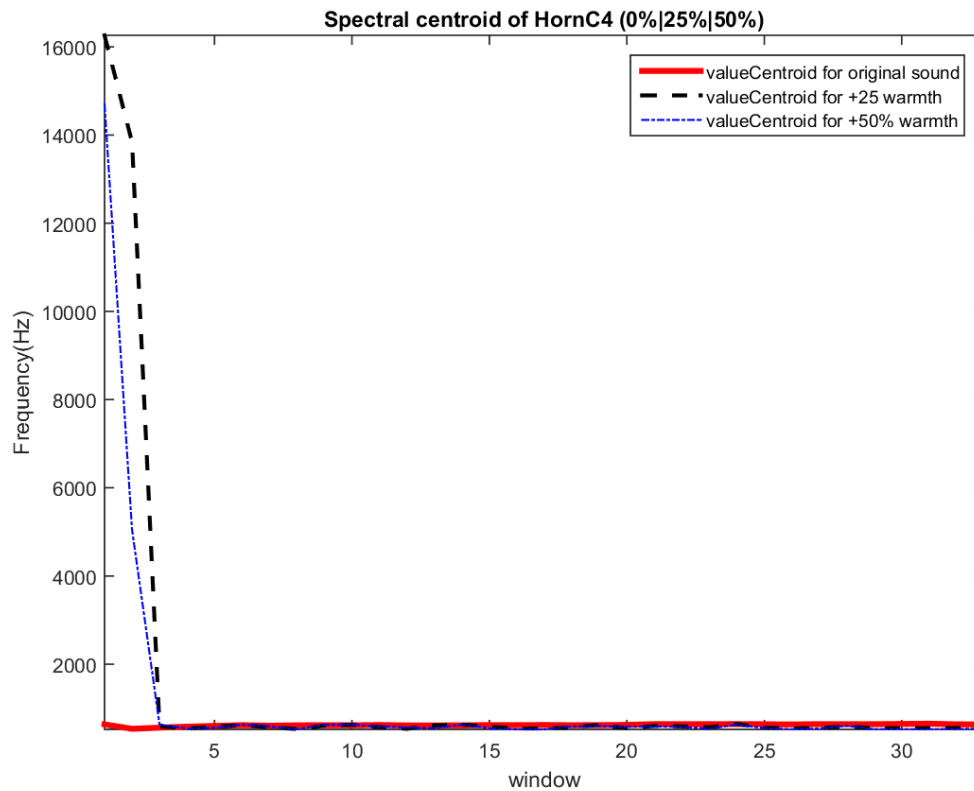

Figure A.50: Variation of the value of the spectral centroid of horn C4, when increased the level of warmth by 25% and 50%, in each analysis audio file

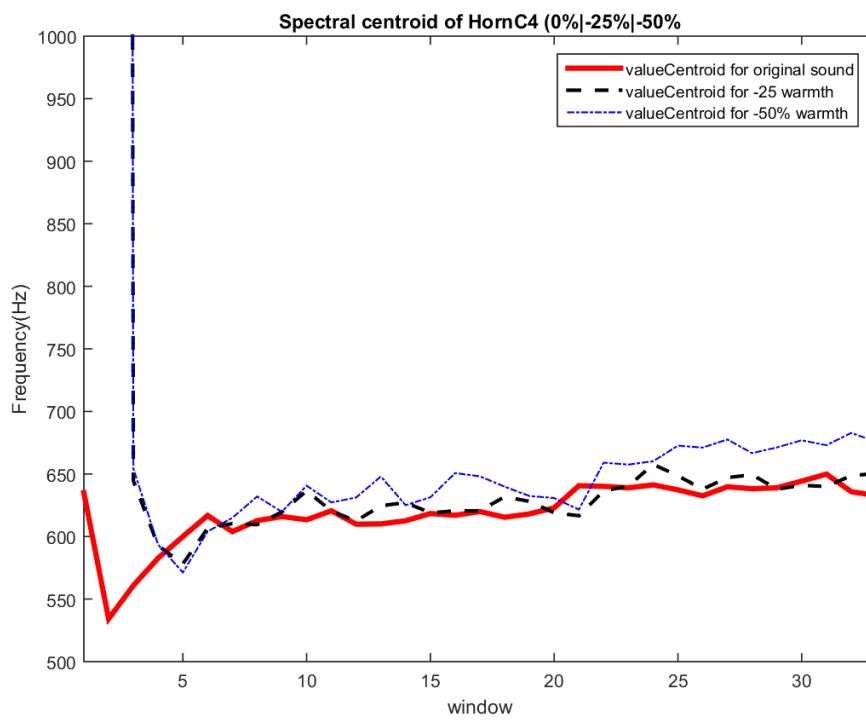

Figure A.51: Variation of the value of the spectral centroid of horn C4, when decreased the level of warmth by 25% and 50%, in each analysis audio file

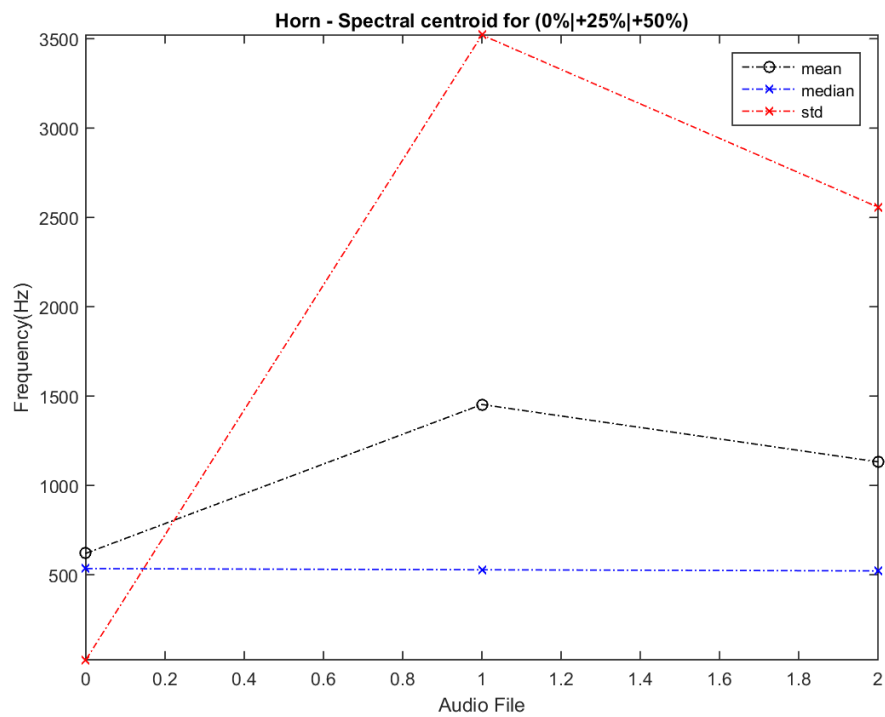

Figure A.52: Mean, median and standard deviation of the spectral centroid of horn C4, when increased the level of warmth by 25% and 50%, in each analysis audio file. The leftmost (at '0') values belong to the sound of horn C4 with no transformation. The values at '1' belong to the sound of horn C4 with +25% warmth and the rightmost (at '2') values belong to the sound of horn C4 with +50% warmth

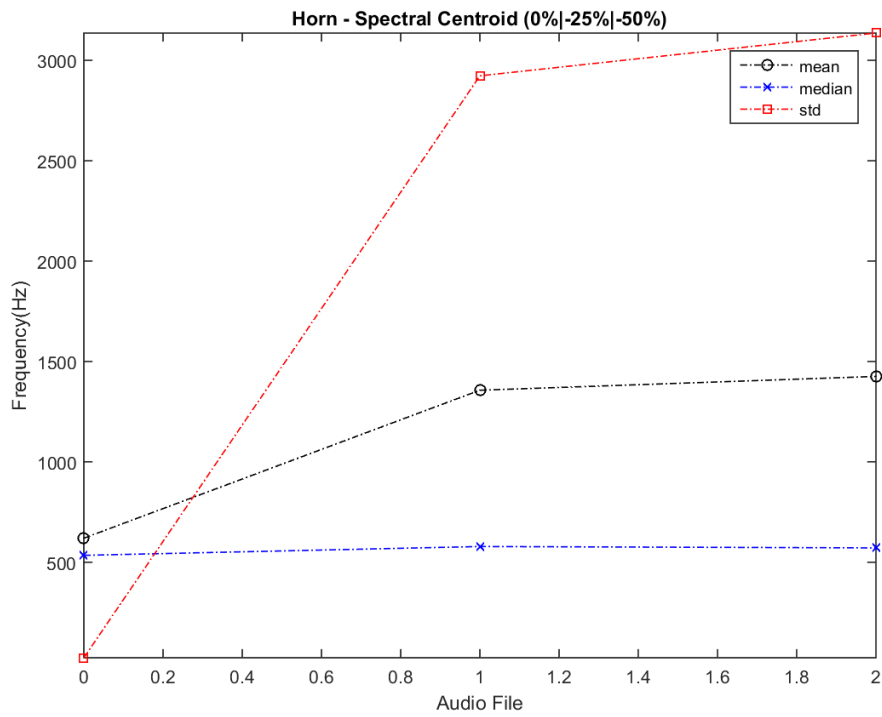

Figure A.53: Mean, median and standard deviation of horn C4 when decreased the level of warmth by 25% and 50%. The leftmost (at '0') values belong to the sound of horn C4 with no transformation. The values at '1' belong to the sound of horn C4 with -25% warmth and the rightmost (at '2') values belong to the sound of horn C4 with -50% warmth

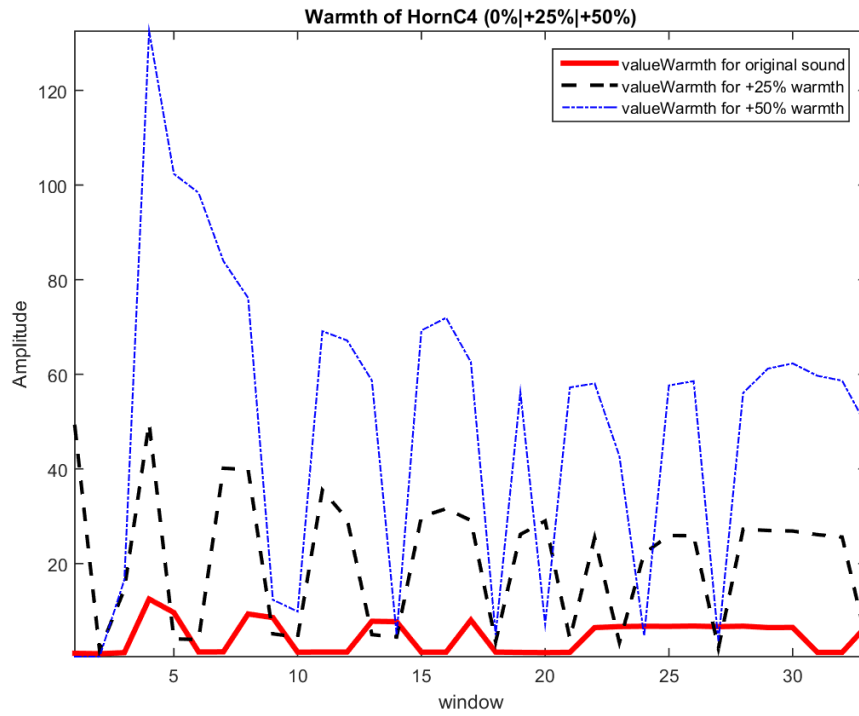

Figure A.54: Variation of the value of warmth of horn C4, when increased the level of warmth by 25% and 50%, in each analysis audio file

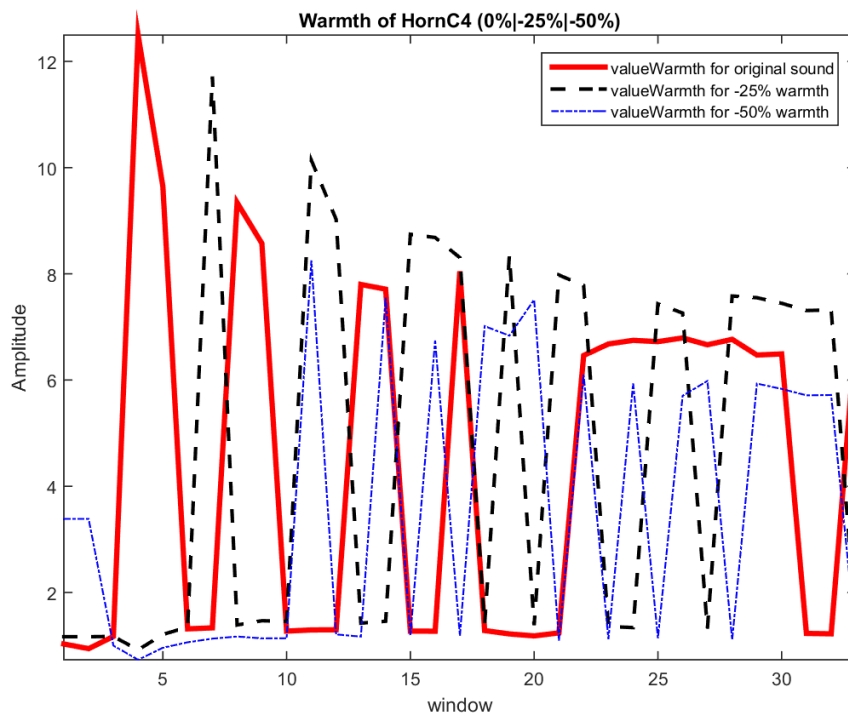

Figure A.55: Variation of the value of warmth of horn C4, when decreased the level of warmth by 25% and 50%, in each analysis audio file

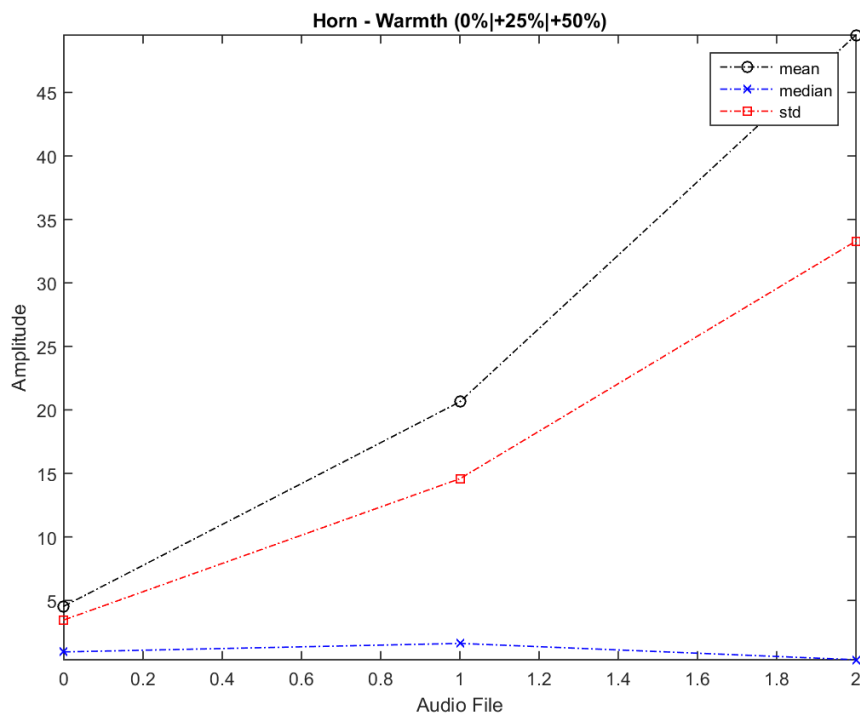

Figure A.56: Mean, median and standard deviation of the warmth of horn C4 when increased the level of warmth by 25% and 50%. The leftmost (at '0') values belong to the sound of horn C4 with no transformation. The values at '1' belong to the sound of horn C4 with +25% warmth and the rightmost (at '2') values belong to the sound of horn C4 with +50% warmth

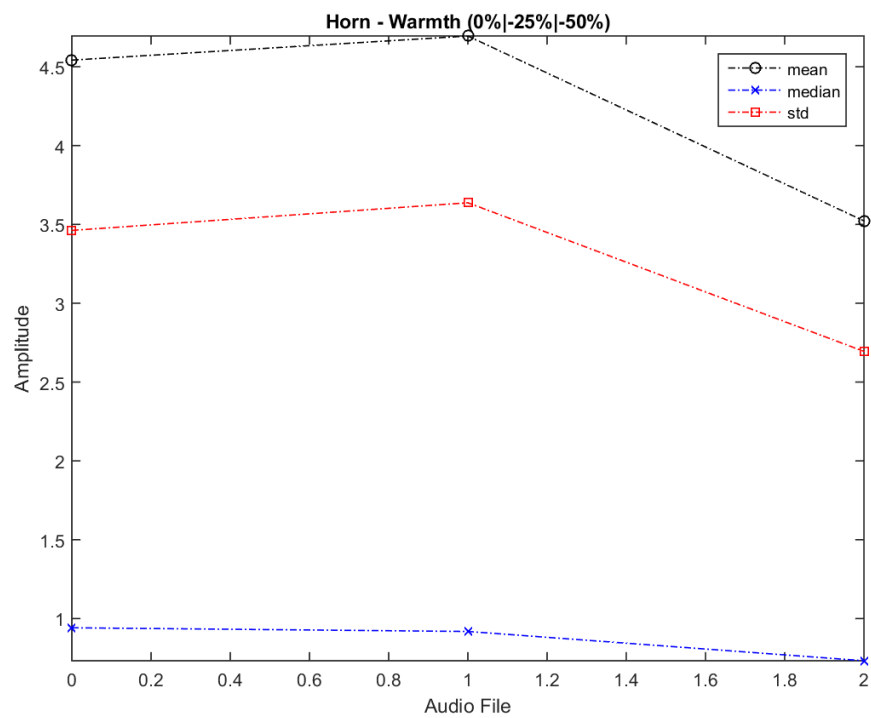

Figure A.57: Mean, median and standard deviation of horn C4 when decreased the level of warmth by 25% and 50%. The leftmost (at '0') values belong to the sound of horn C4 with no transformation. The values at '1' belongs to the sound of horn C4 with -25% warmth and the rightmost (at '2') values belong to the sound of horn C4 with -50% warmth

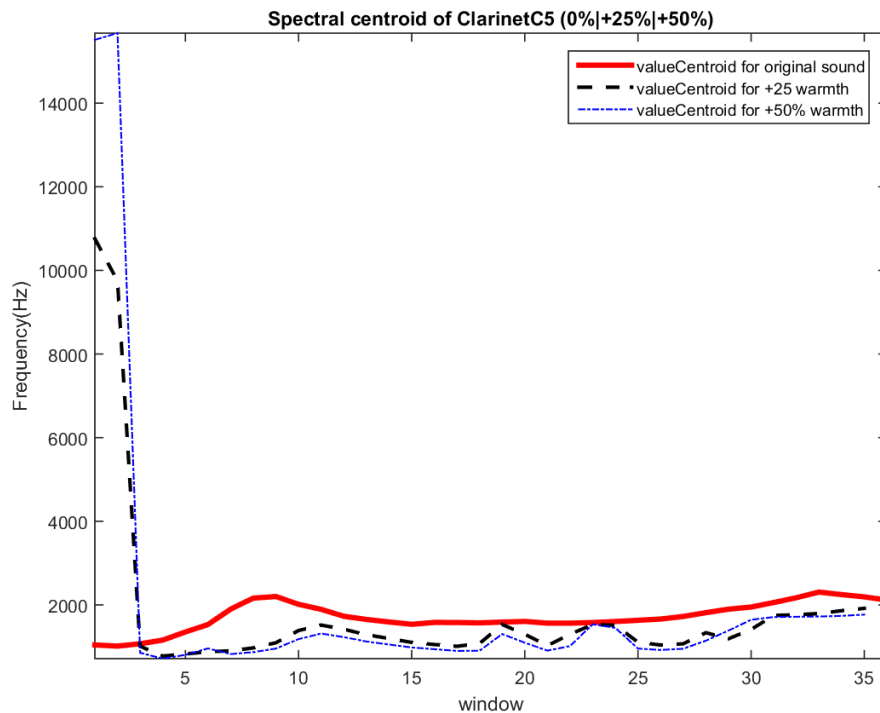

Figure A.58: Variation of the value of the spectral centroid of clarinet C5, when increased the level of warmth by 25% and 50%, in each analysis audio file

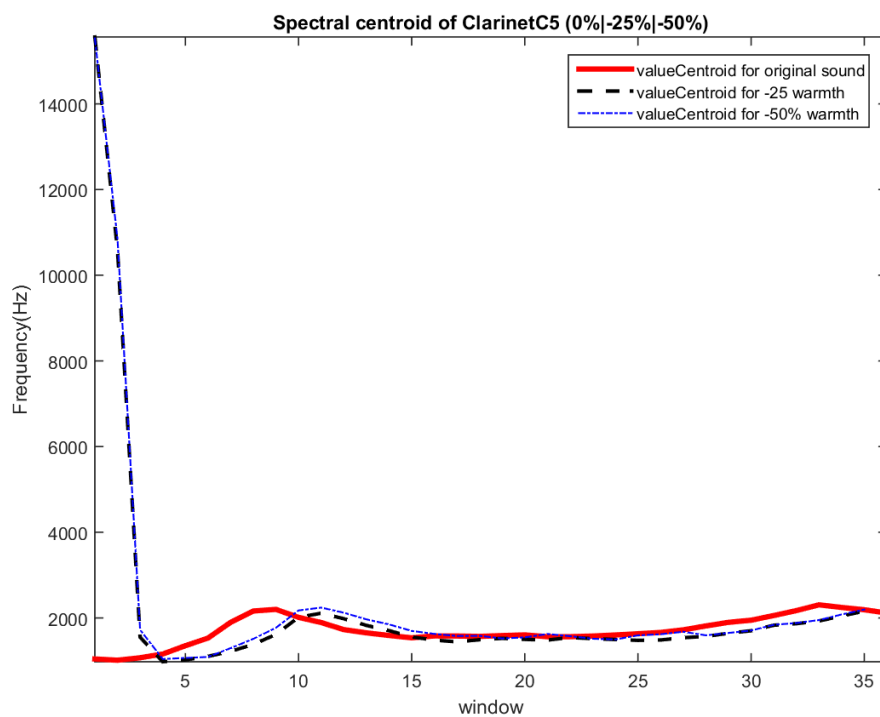

Figure A.59: Variation of the value of the spectral centroid of clarinet C5, when decreased the level of warmth by 25% and 50%, in each analysis audio file

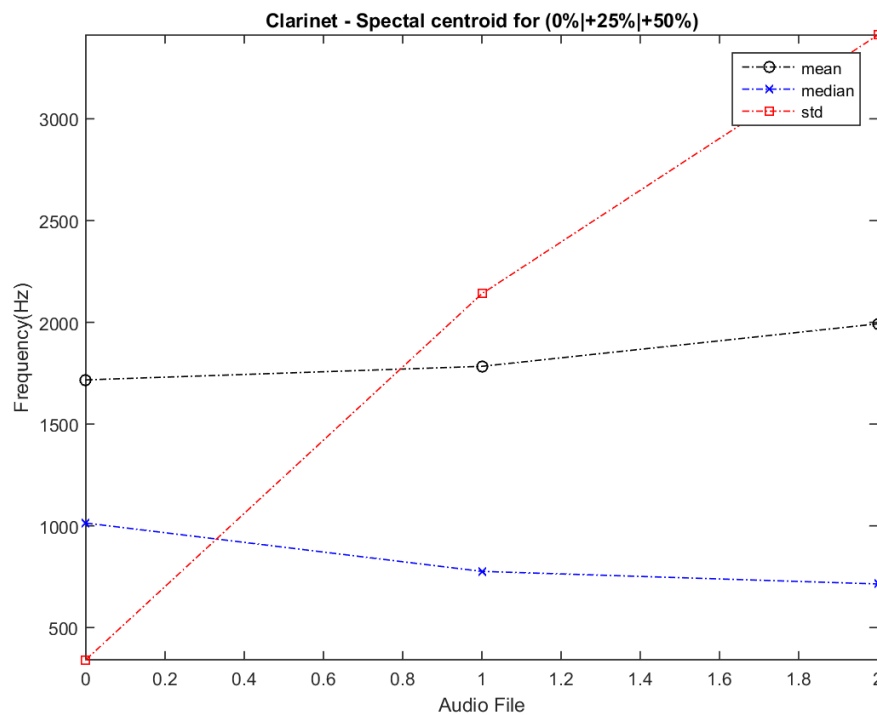

Figure A.60: Mean, median and standard deviation of the spectral centroid of clarinet C5, when increased the level of warmth by 25% and 50%, in each analysis audio file. The leftmost (at '0') values belong to the sound of clarinet C5 with no transformation. The values at '1' belongs to the sound of clarinet C5 with +25% warmth and the rightmost (at '2') values belong to the sound of clarinet C5 with +50% warmth

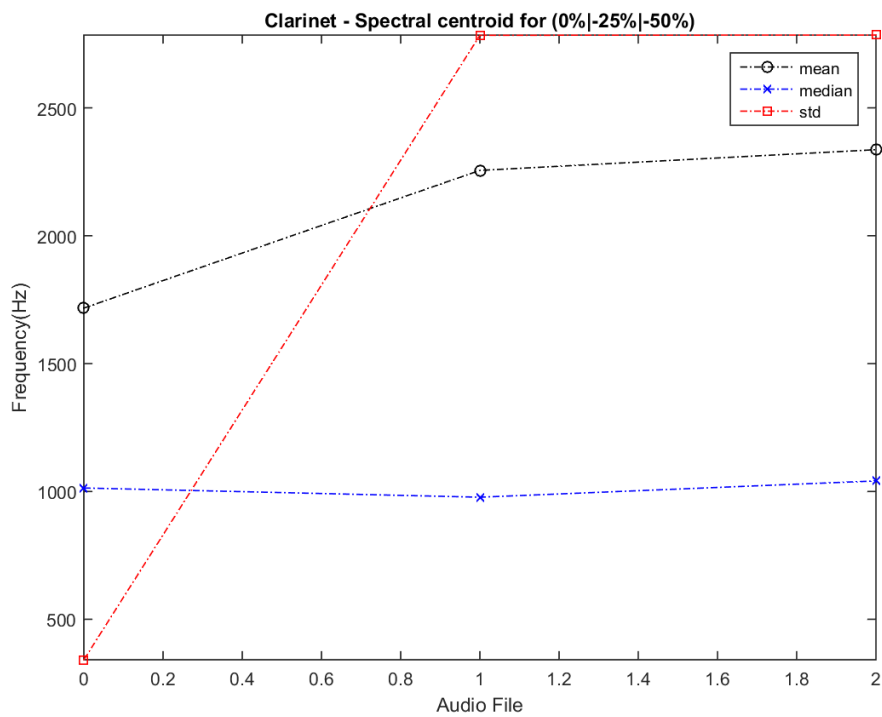

Figure A.61: Mean, median and standard deviation of clarinet C5 when decreased the level of warmth by 25% and 50%. The leftmost (at '0') values belong to the sound of clarinet C5 with no transformation. The values at '1' belong to the sound of clarinet C5 with -25% warmth and the rightmost (at '2') values belong to the sound of clarinet C5 with -50% warmth

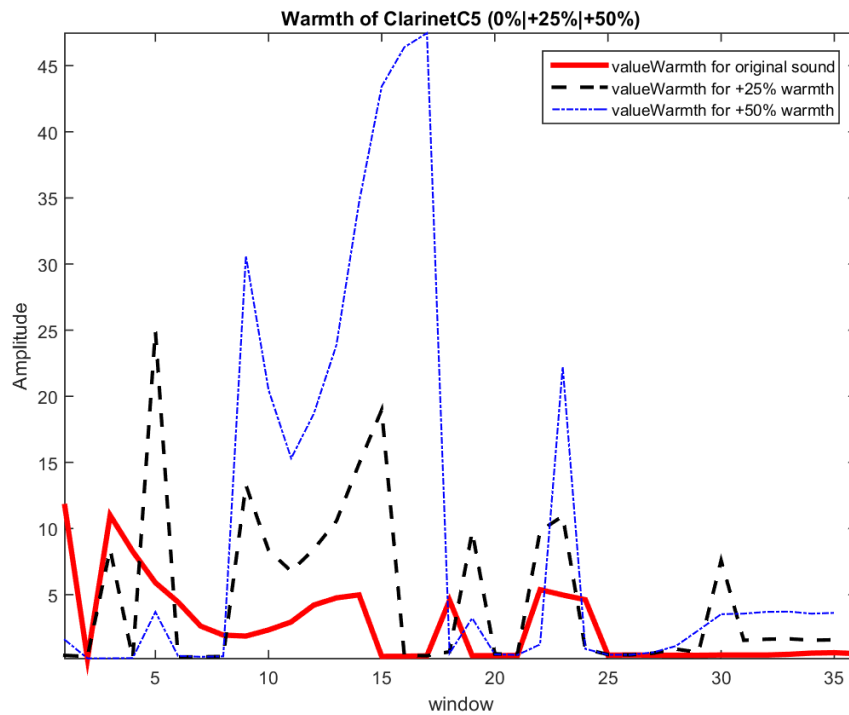

Figure A.62: Variation of the value of warmth of clarinet C5, when increased the level of warmth by 25% and 50%, in each analysis audio file

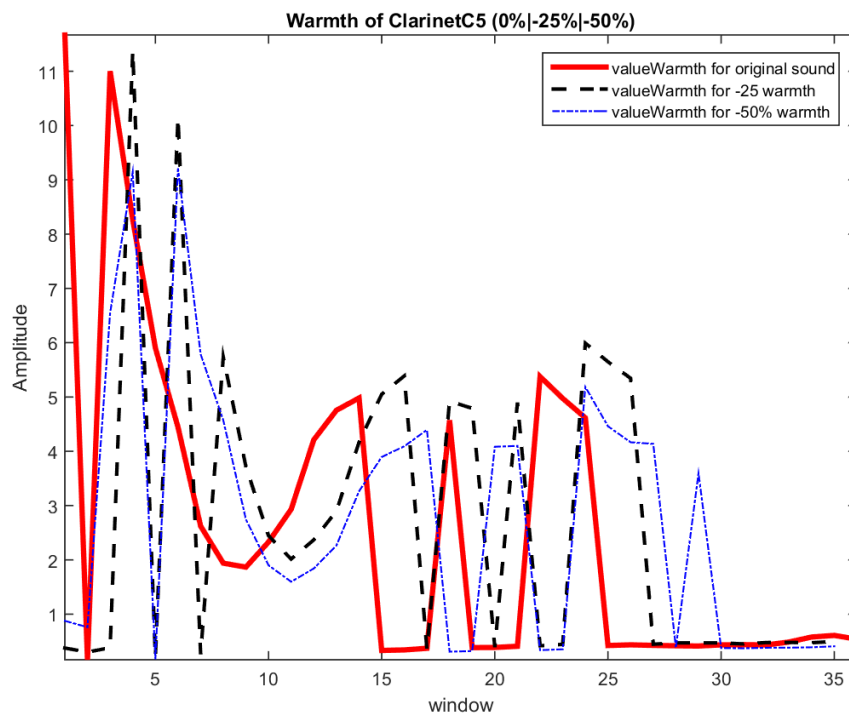

Figure A.63: Variation of the value of warmth of clarinet C5, when decreased the level of warmth by 25% and 50%, in each analysis audio file

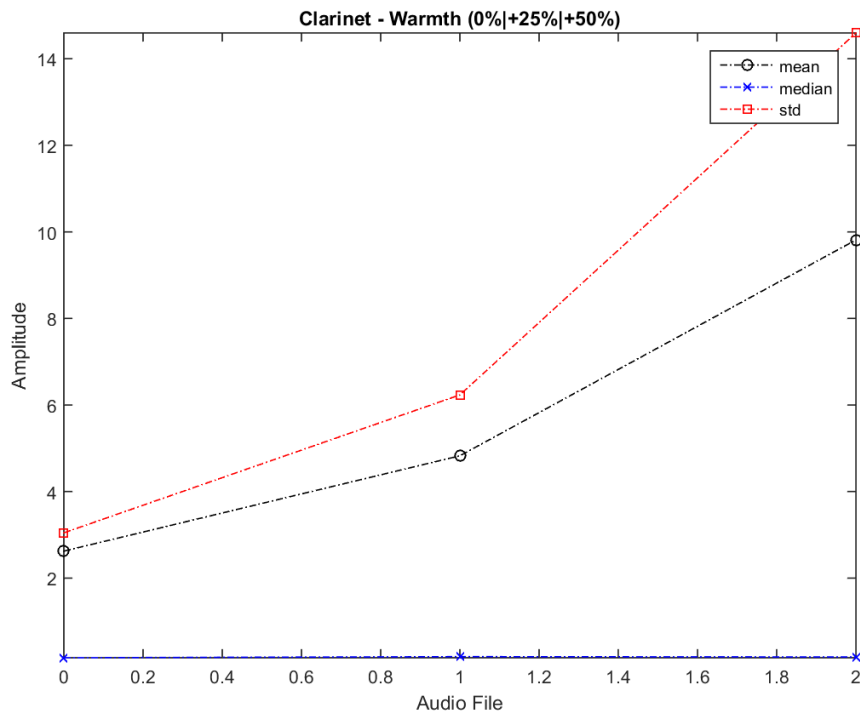

Figure A.64: Mean, median and standard deviation of the warmth of clarinet C5 when increased the level of warmth by 25% and 50%. The leftmost (at '0') values belong to the sound of clarinet C5 with no transformation. The values at '1' belong to the sound of clarinet C5 with +25% warmth and the rightmost (at '2') values belong to the sound of clarinet C5 with +50% warmth

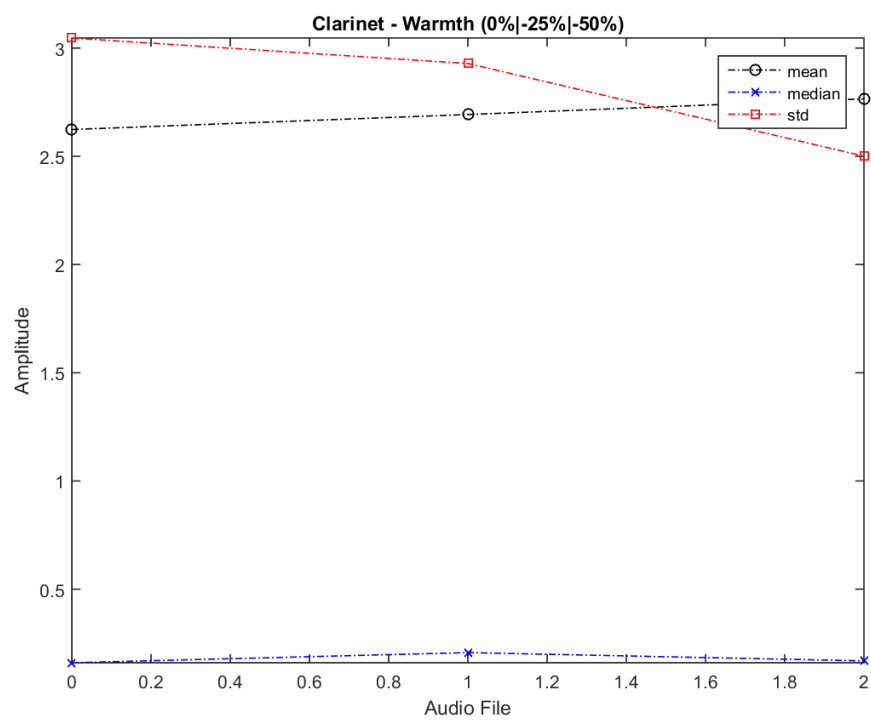

Figure A.65: Mean, median and standard deviation of clarinet C5 when decreased the level of warmth by 25% and 50%. The leftmost (at '0') values belong to the sound of clarinet C5 with no transformation. The values at '1' belong to the sound of clarinet C5 with -25% warmth and the rightmost (at '2') values belong to the sound of clarinet C5 with -50% warmth

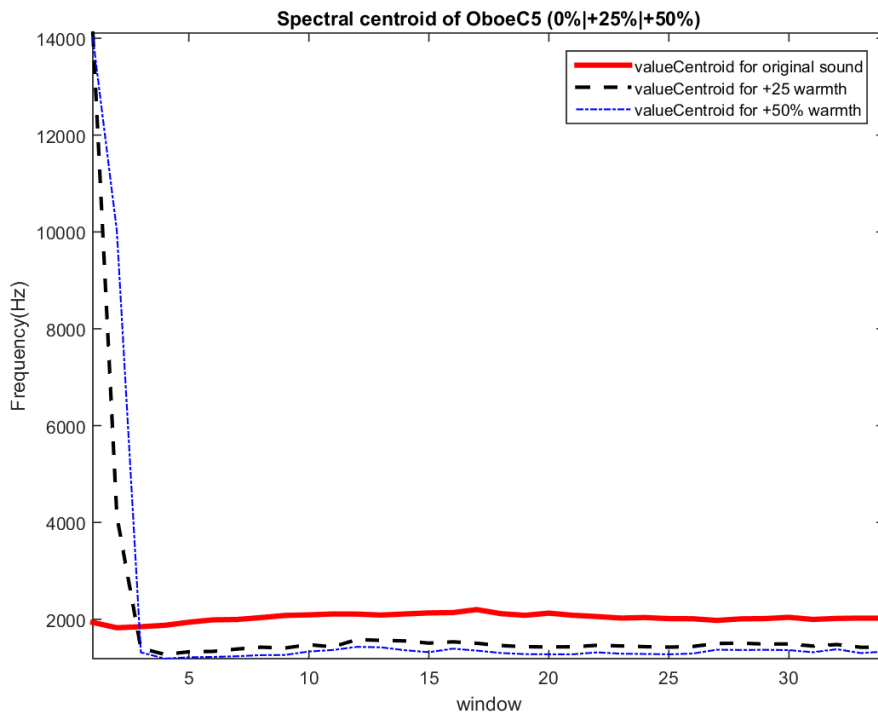

Figure A.66: Variation of the value of the spectral centroid of oboe C5, when increased the level of warmth by 25% and 50%, in each analysis audio file

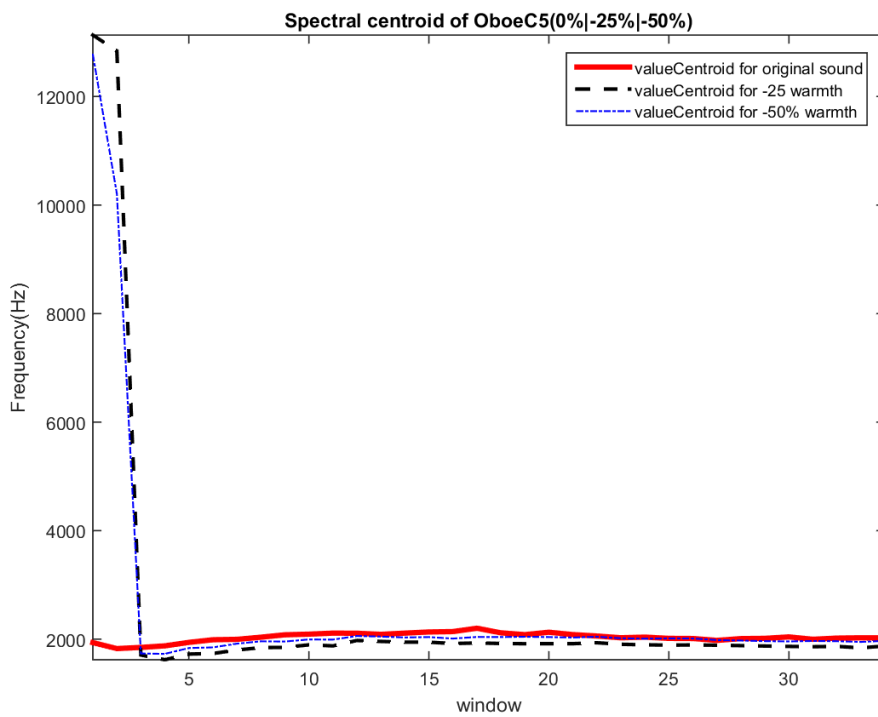

Figure A.67: Variation of the value of the spectral centroid of oboe C5, when decreased the level of warmth by 25% and 50%, in each analysis audio file

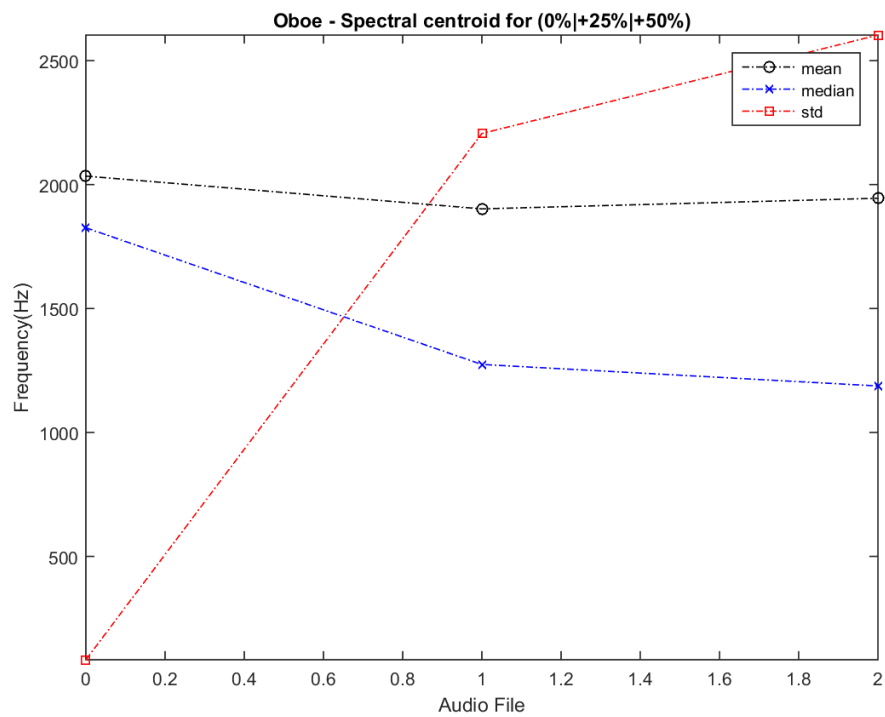

Figure A.68: Mean, median and standard deviation of the spectral centroid of oboe C5, when increased the level of warmth by 25% and 50%, in each analysis audio file. The leftmost (at '0') values belong to the sound of oboe C5 with no transformation. The values at '1' belong to the sound of oboe C5 with +25% warmth and the rightmost (at '2') values belong to the sound of oboe C5 with +50% warmth

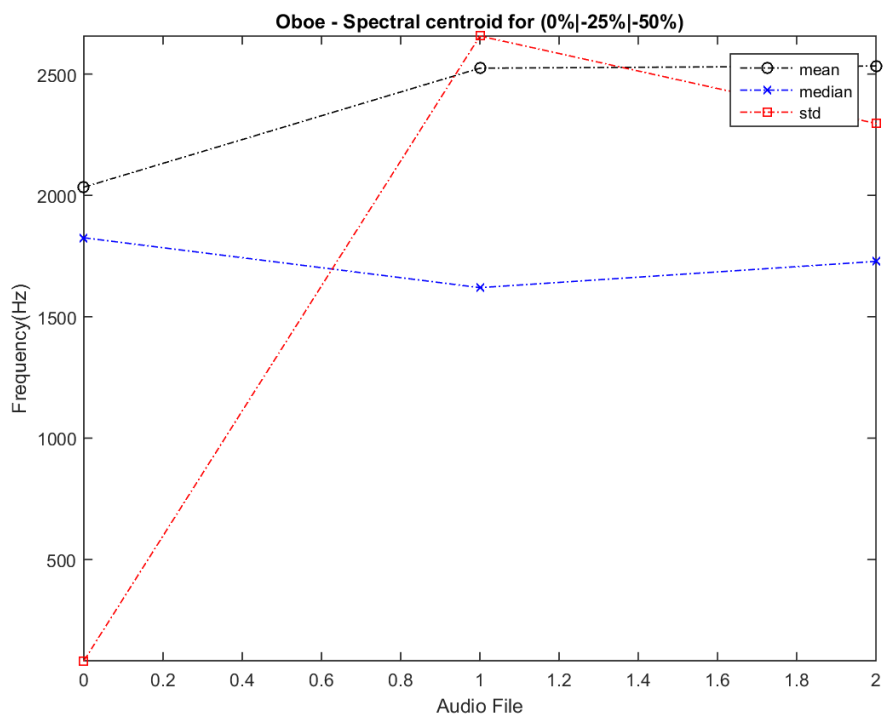

Figure A.69: Mean, median and standard deviation of oboe C5 when decreased the level of warmth by 25% and 50%. The leftmost (at '0') values belong to the sound of oboe C5 with no transformation. The values at '1' belongs to the sound of oboe C5 with -25% warmth and the rightmost (at '2') values belong to the sound of oboe C5 with -50% warmth

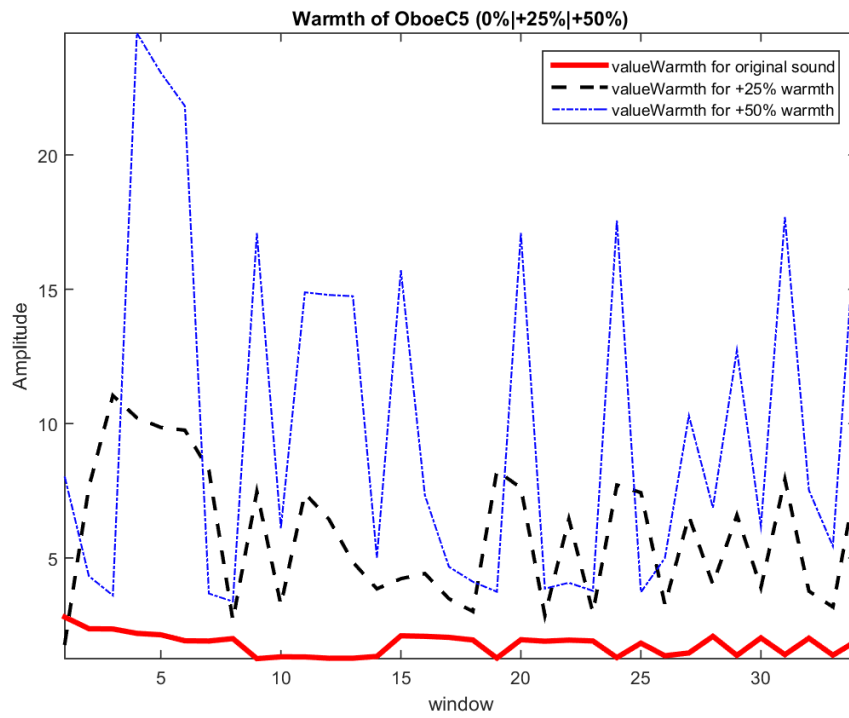

Figure A.70: Variation of the value of warmth of oboe C5, when increased the level of warmth by 25% and 50%, in each analysis audio file

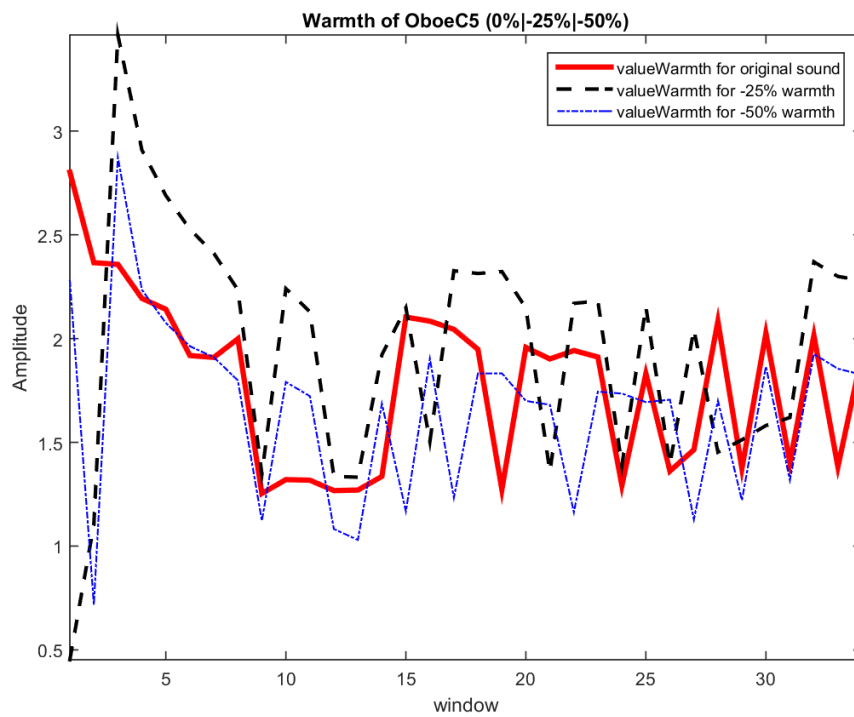

Figure A.71: Variation of the value of warmth of oboe C5, when decreased the level of warmth by 25% and 50%, in each analysis audio file

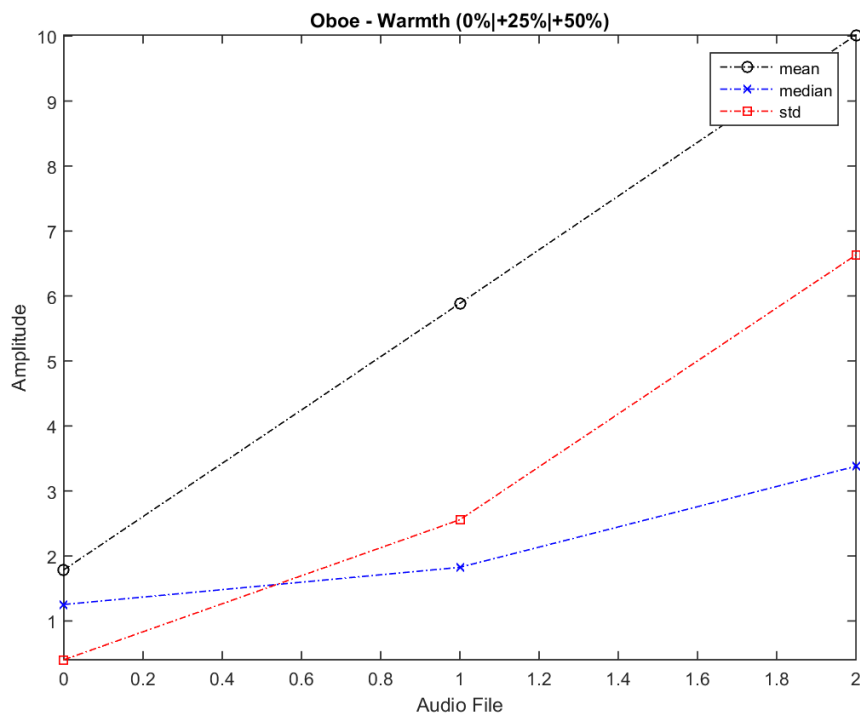

Figure A.72: Mean, median and standard deviation of the warmth of oboe C5 when increased the level of warmth by 25% and 50%. The leftmost (at '0') values belong to the sound of oboe C5 with no transformation. The values at '1' belong to the sound of oboe C5 with +25% warmth and the rightmost (at '2') values belong to the sound of oboe C5 with +50% warmth

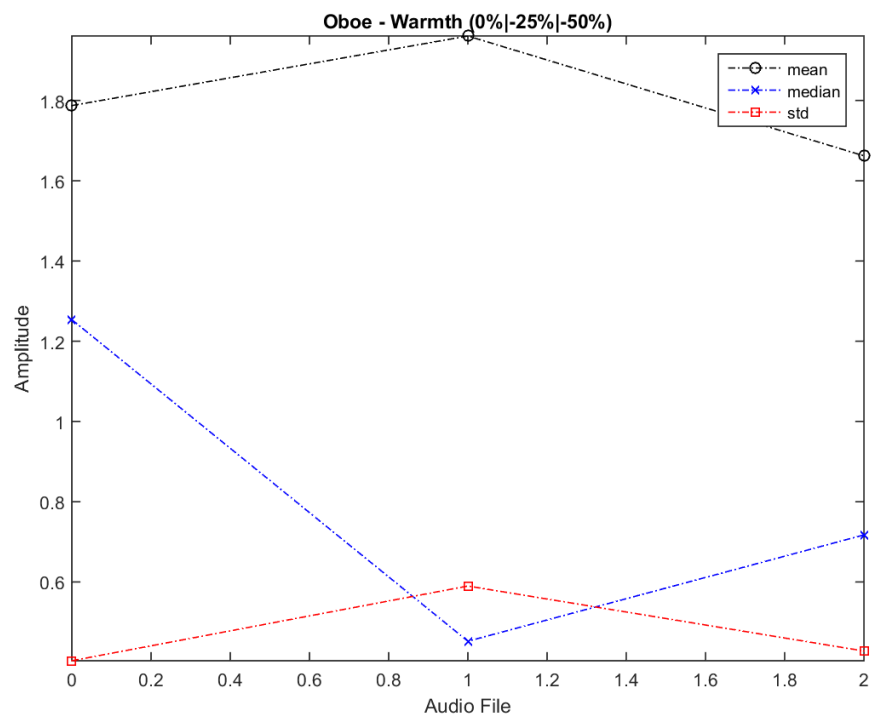

Figure A.73: Mean, median and standard deviation of oboe C5 when decreased the level of warmth by 25% and 50%. The leftmost (at '0') values belong to the sound of oboe C5 with no transformation. The values at '1' belongs to the sound of oboe C5 with -25% warmth and the rightmost (at '2') values belong to the sound of oboe C5 with -50% warmth

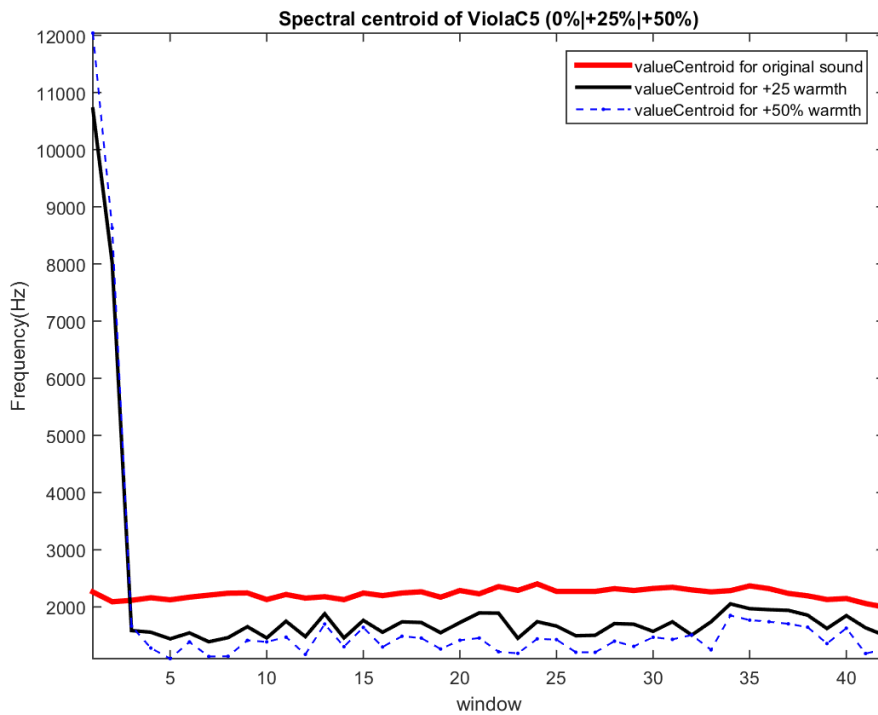

Figure A.74: Variation of the value of the spectral centroid of viola C5, when increased the level of warmth by 25% and 50%, in each analysis audio file

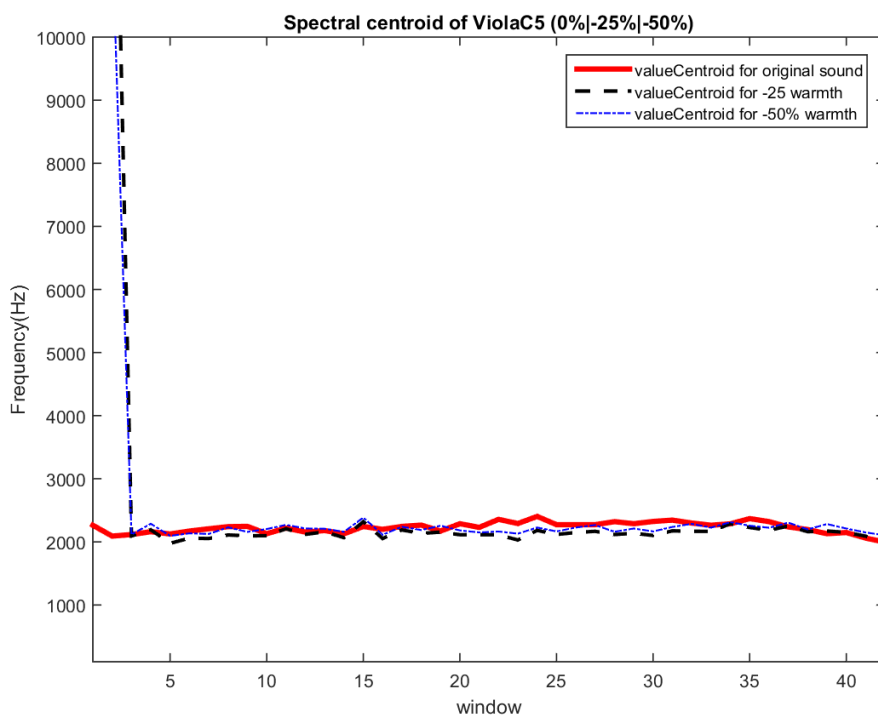

Figure A.75: Variation of the value of the spectral centroid of viola C5, when decreased the level of warmth by 25% and 50%, in each analysis audio file

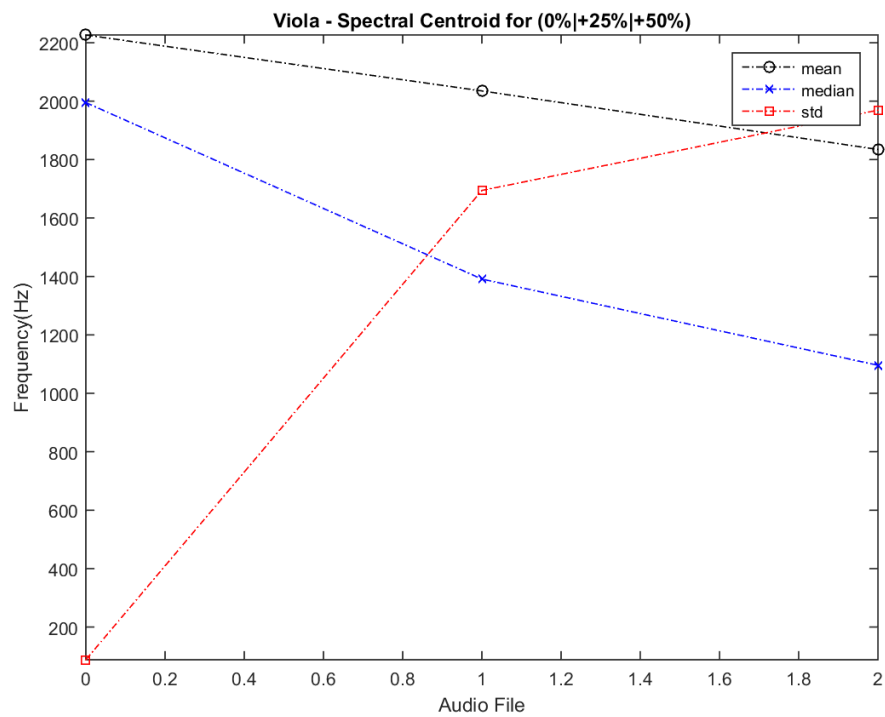

Figure A.76: Mean, median and standard deviation of the spectral centroid of viola C5, when increased the level of warmth by 25% and 50%, in each analysis audio file. The leftmost (at '0') values belong to the sound of viola C5 with no transformation. The values at '1' belong to the sound of viola C5 with +25% warmth and the rightmost (at '2') values belong to the sound of viola C5 with +50% warmth

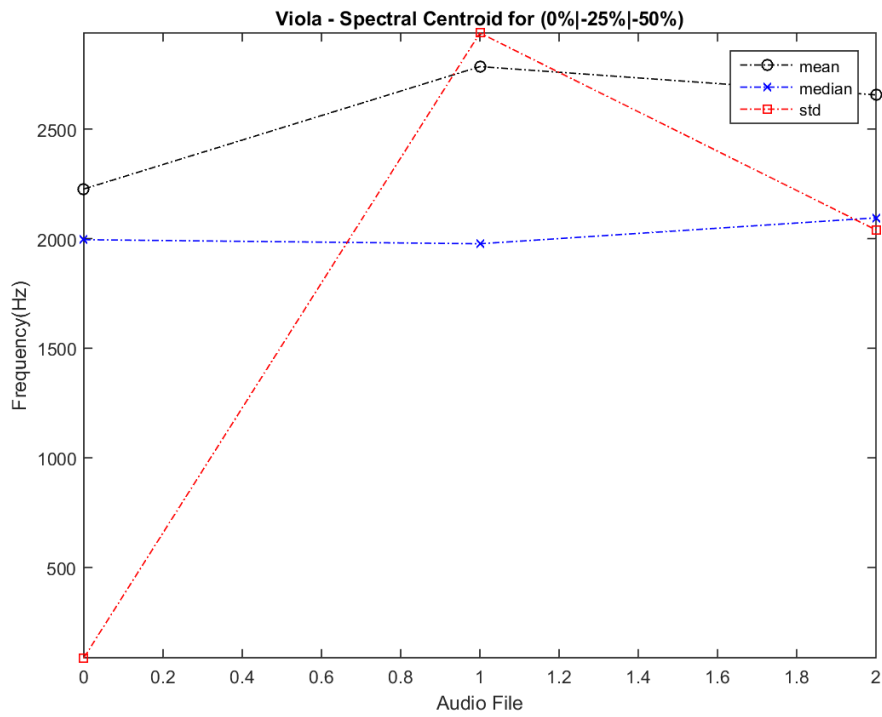

Figure A.77: Mean, median and standard deviation of viola C5 when decreased the level of warmth by 25% and 50%. The leftmost (at '0') values belong to the sound of viola C5 with no transformation. The values at '1' belongs to the sound of viola C5 with -25% warmth and the rightmost (at '2') values belong to the sound of viola C5 with -50% warmth

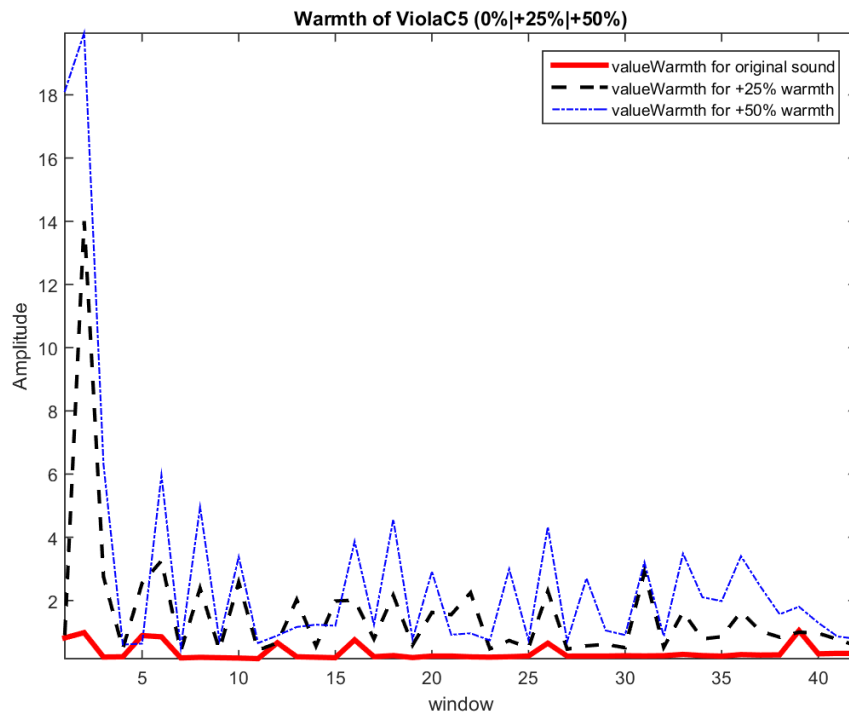

Figure A.78: Variation of the value of warmth of viola C5, when increased the level of warmth by 25% and 50%, in each analysis audio file

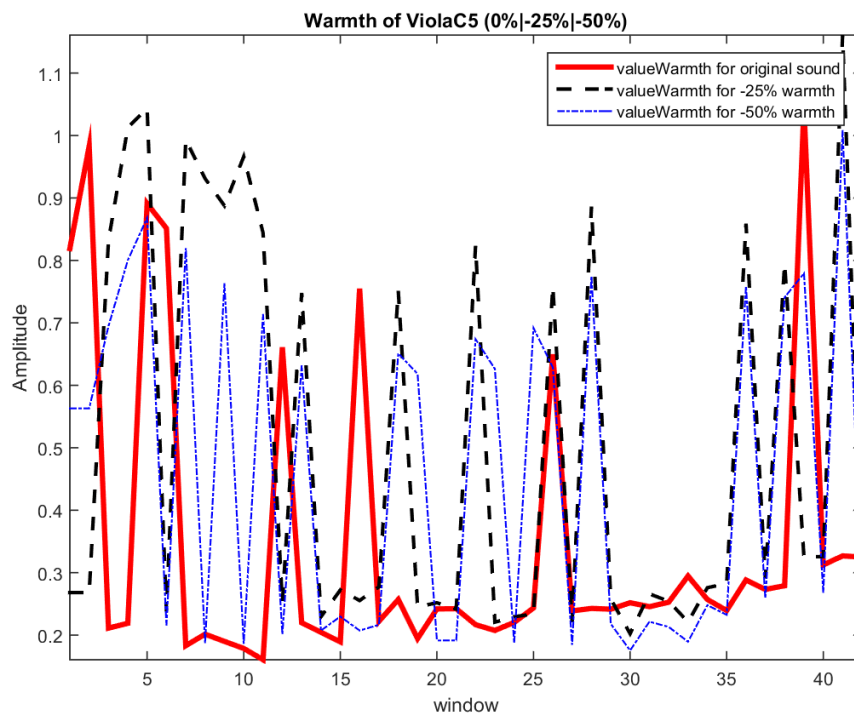

Figure A.79: Variation of the value of warmth of viola C5, when decreased the level of warmth by 25% and 50%, in each analysis audio file

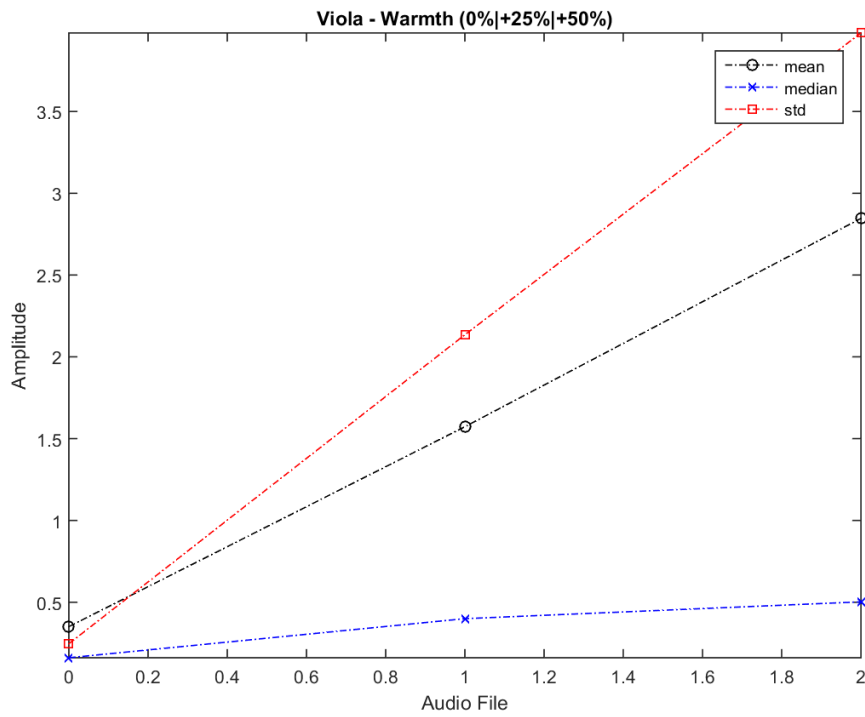

Figure A.80: Mean, median and standard deviation of the warmth of viola C5 when increased the level of warmth by 25% and 50%. The leftmost (at '0') values belong to the sound of viola C5 with no transformation. The values at '1' belong to the sound of viola C5 with +25% warmth and the rightmost (at '2') values belong to the sound of viola C5 with +50% warmth

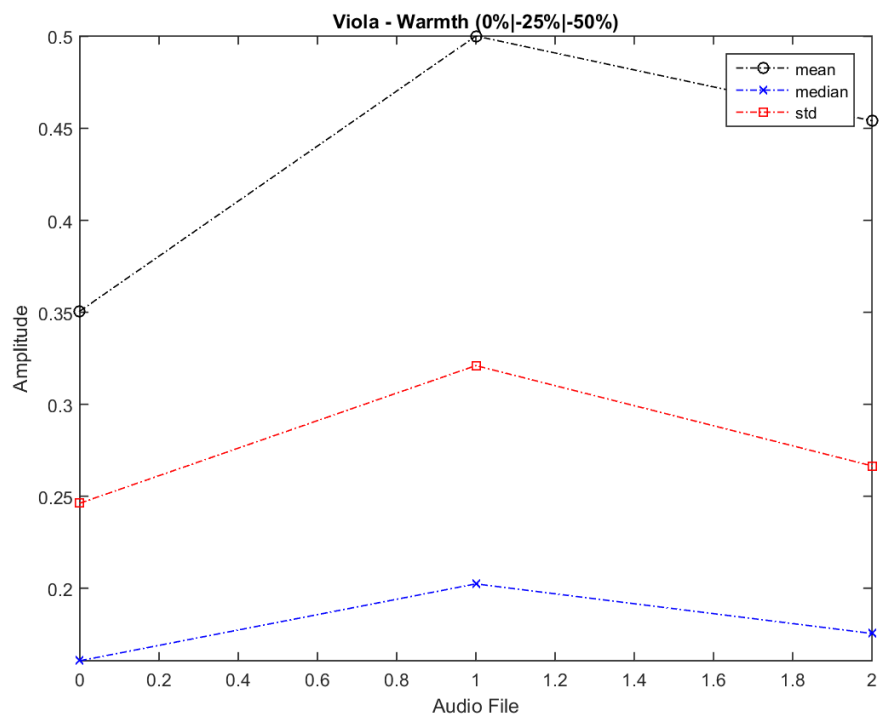

Figure A.81: Mean, median and standard deviation of viola C5 when decreased the level of warmth by 25% and 50%. The leftmost (at '0') values belong to the sound of viola C5 with no transformation. The values at '1' belongs to the sound of viola C5 with -25% warmth and the rightmost (at '2') values belong to the sound of viola C5 with -50% warmth

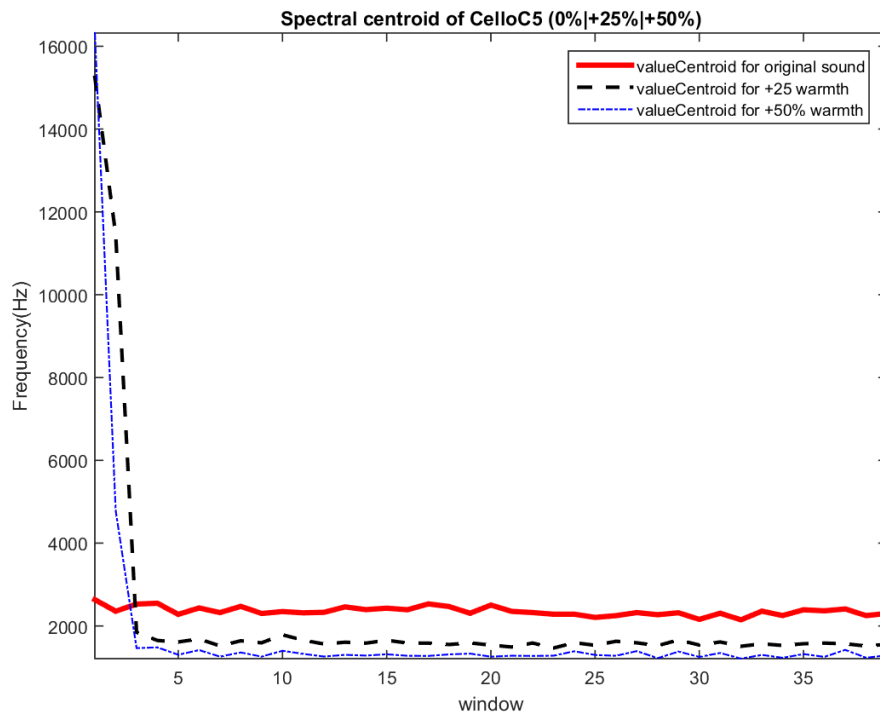

Figure A.82: Variation of the value of the spectral centroid of violoncello C5, when increased the level of warmth by 25% and 50%, in each analysis audio file

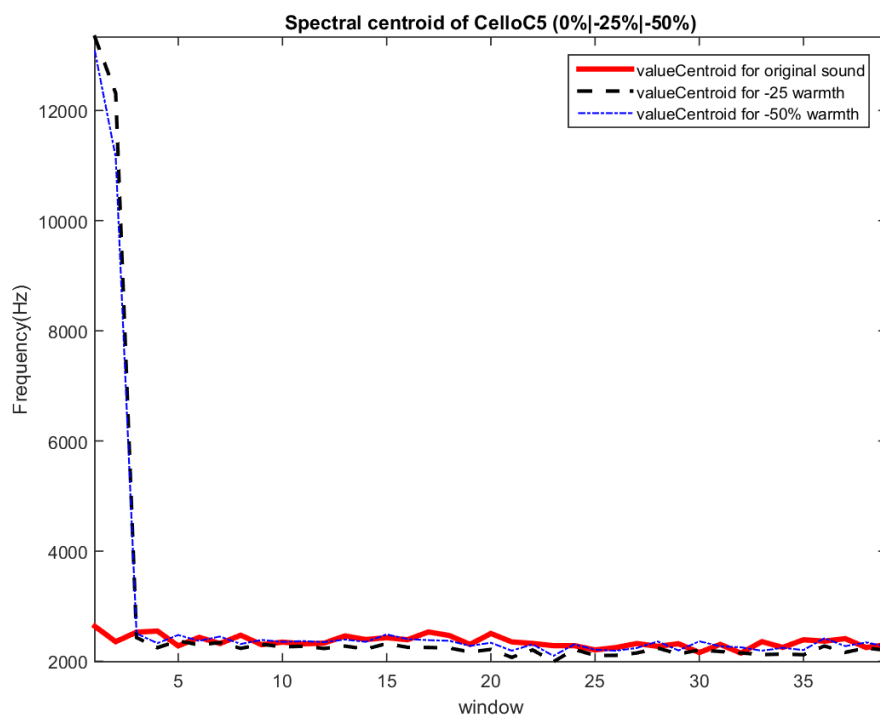

Figure A.83: Variation of the value of the spectral centroid of violoncello C5, when decreased the level of warmth by 25% and 50%, in each analysis audio file

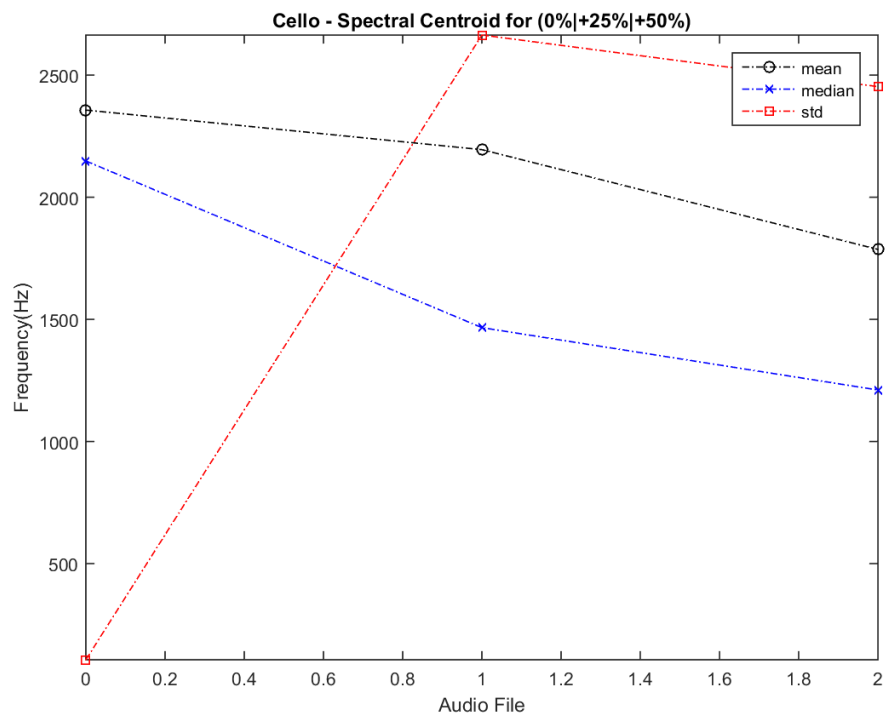

Figure A.84: Mean, median and standard deviation of the spectral centroid of violoncello C5, when increased the level of warmth by 25% and 50%, in each analysis audio file. The leftmost (at '0') values belong to the sound of violoncello C5 with no transformation. The values at '1' belongs to the sound of violoncello C5 with +25% warmth and the rightmost (at '2') values belong to the sound of violoncello C5 with +50% warmth

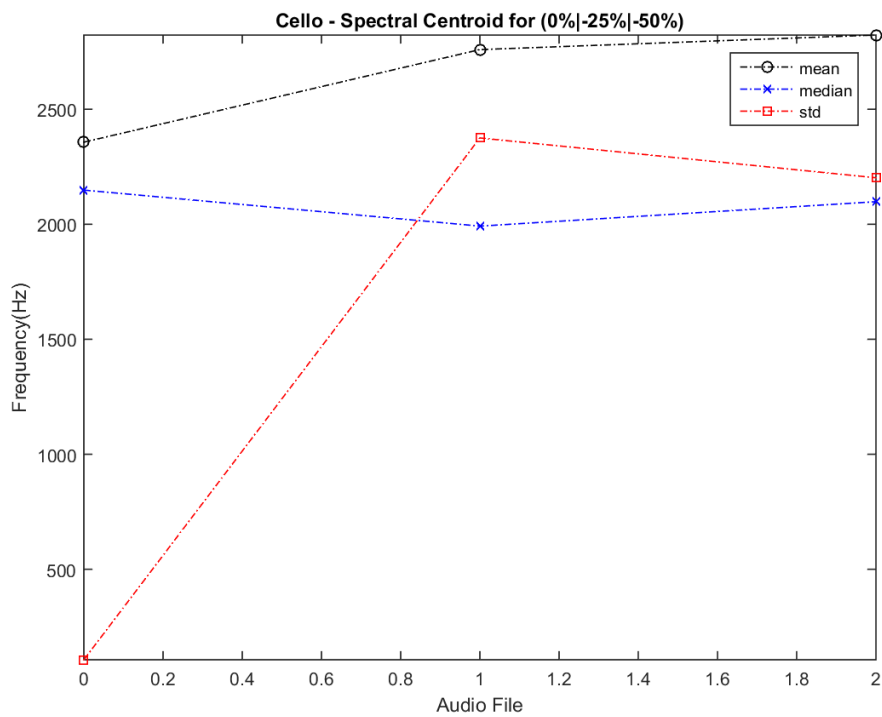

Figure A.85: Mean, median and standard deviation of violoncello C5 when decreased the level of warmth by 25% and 50%. The leftmost (at '0') values belong to the sound of violoncello C5 with no transformation. The values at '1' belongs to the sound of violoncello C5 with -25% warmth and the rightmost (at '2') values belong to the sound of violoncello C5 with -50% warmth

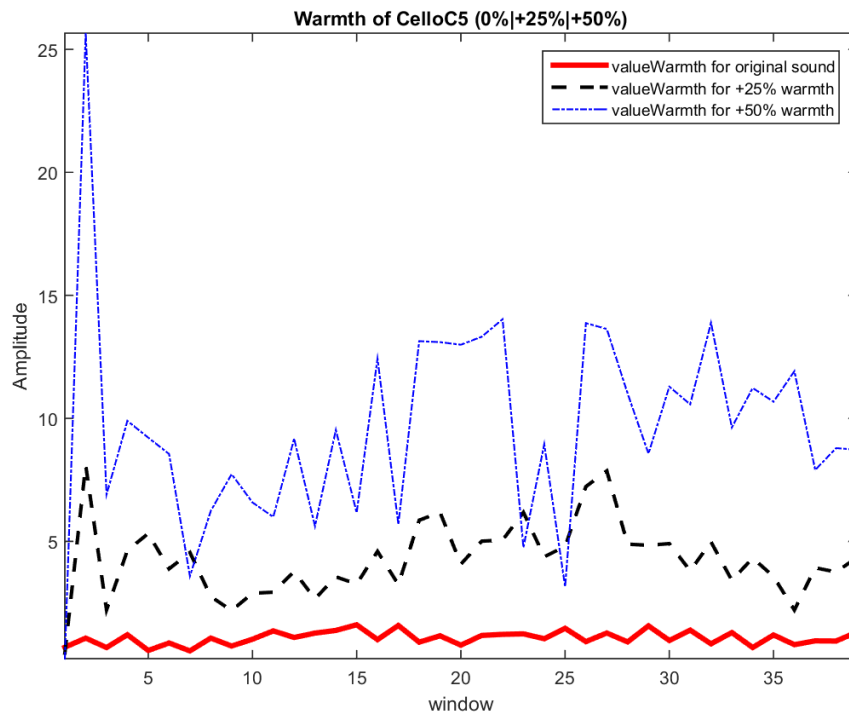

Figure A.86: Variation of the value of warmth of violoncello C5, when increased the level of warmth by 25% and 50%, in each analysis audio file

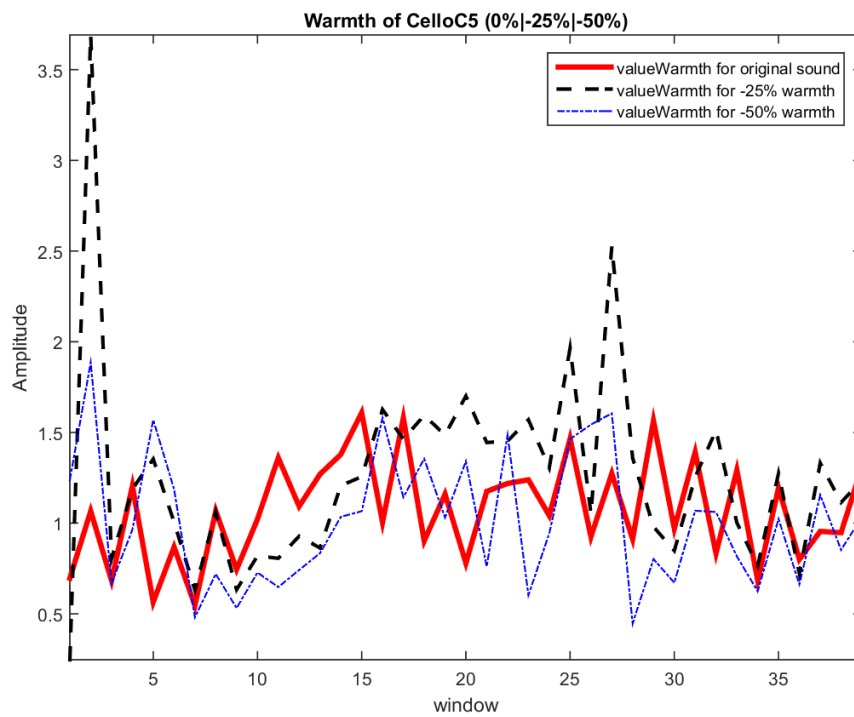

Figure A.87: Variation of the value of warmth of violoncello C5, when decreased the level of warmth by 25% and 50%, in each analysis audio file

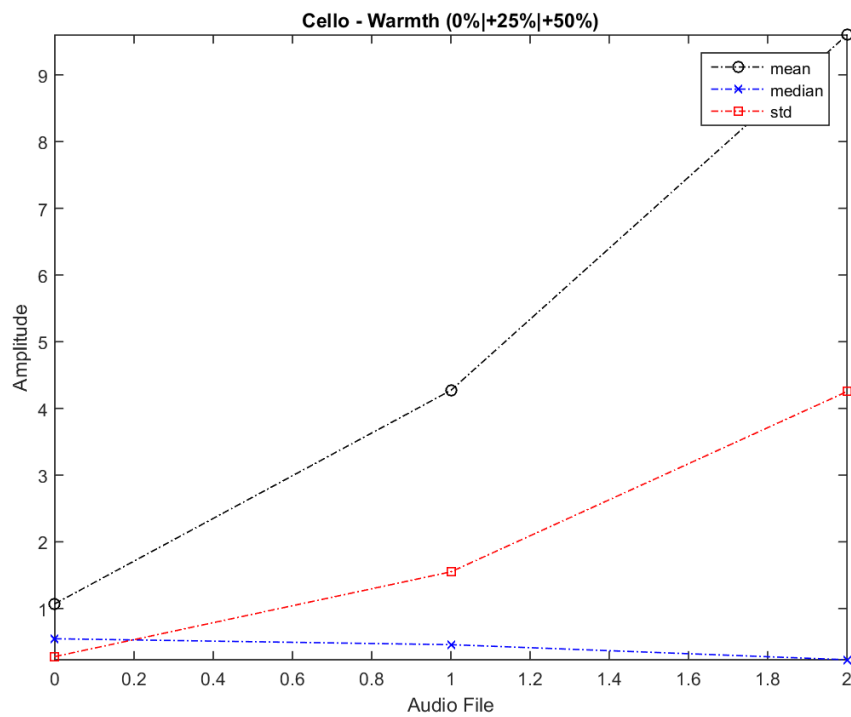

Figure A.88: Mean, median and standard deviation of the warmth of violoncello C5 when increased the level of warmth by 25% and 50%. The leftmost (at '0') values belong to the sound of violoncello C5 with no transformation. The values at '1' belong to the sound of violoncello C5 with +25% warmth and the rightmost (at '2') values belong to the sound of violoncello C5 with +50% warmth

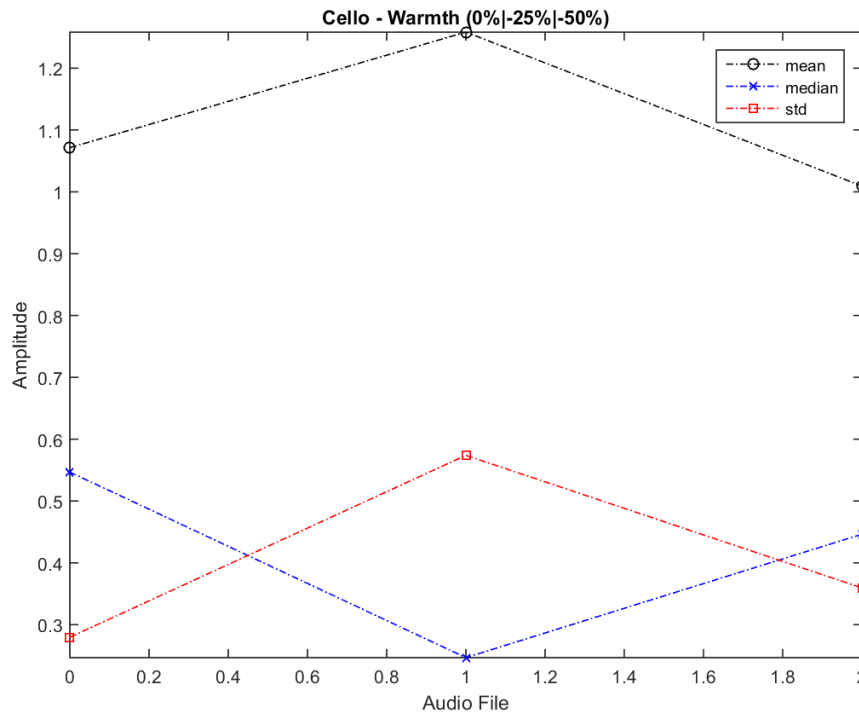

Figure A.89: Mean, median and standard deviation of violoncello C5 when decreased the level of warmth by 25% and 50%. The leftmost (at '0') values belong to the sound of violoncello C5 with no transformation. The values at '1' belongs to the sound of violoncello C5 with -25% warmth and the rightmost (at '2') values belong to the sound of violoncello C5 with -50% warmth

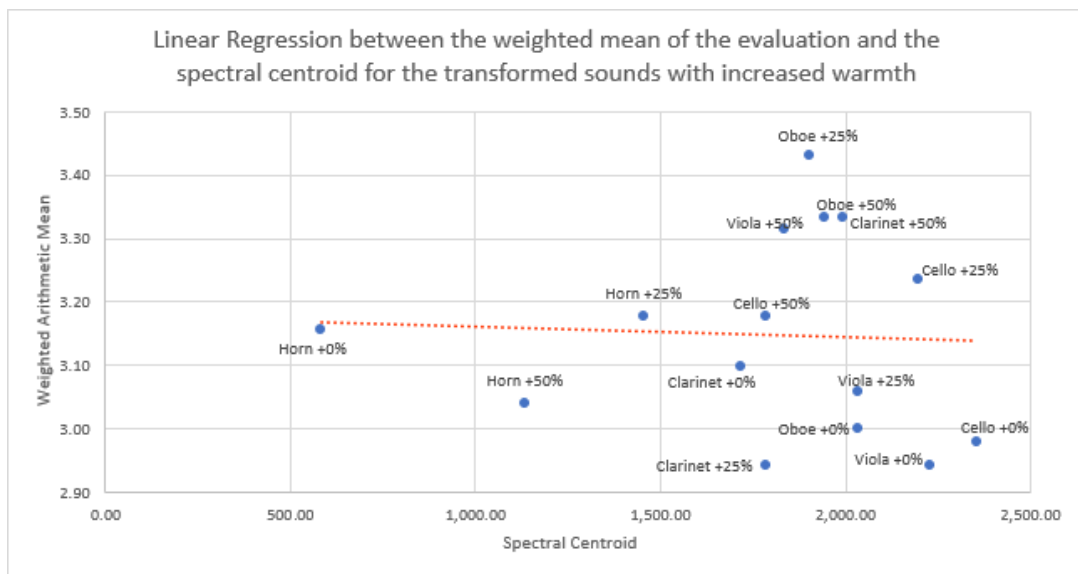

Figure A.90: Linear regression between the weighted arithmetic mean evaluation and the spectral centroid of the sounds with increased level of warmth

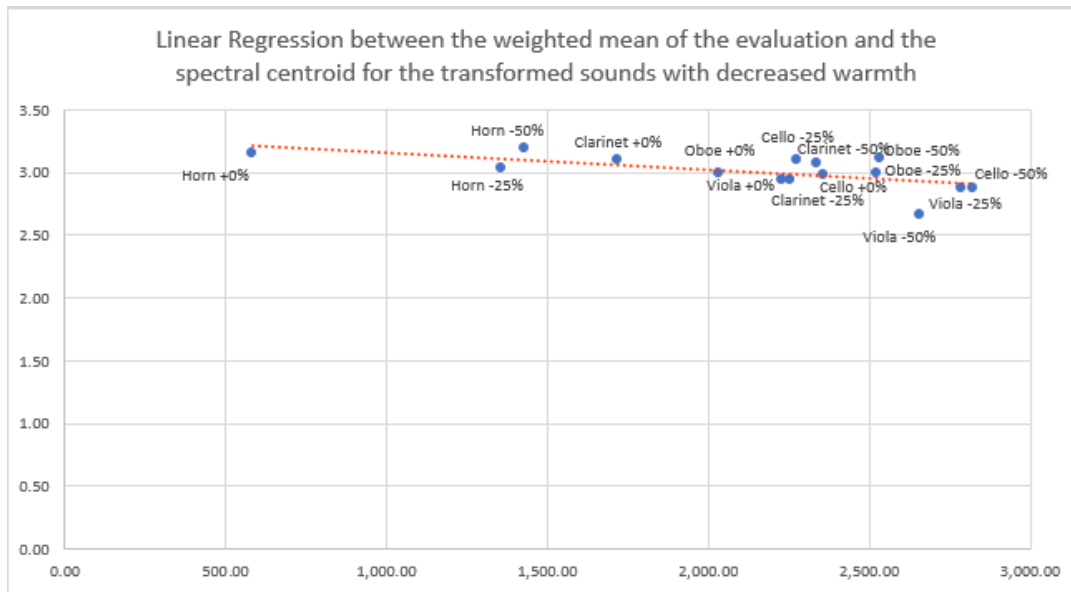

Figure A.91: Linear regression between the weighted arithmetic mean evaluation and the spectral centroid of the sounds with decreased level of warmth

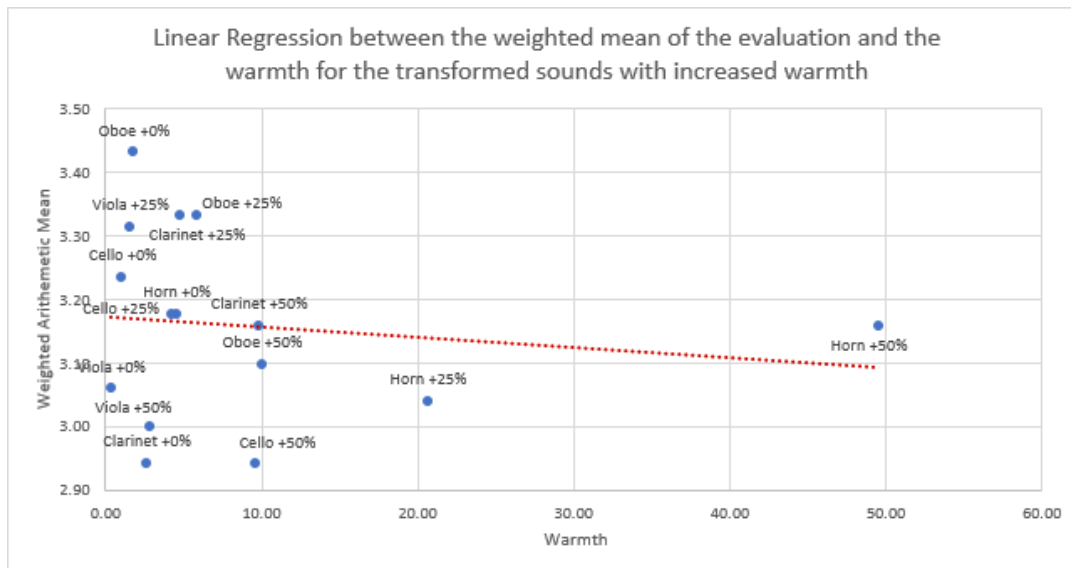

Figure A.92: Linear regression between the weighted arithmetic mean evaluation and the warmth of the sounds with increased level of warmth

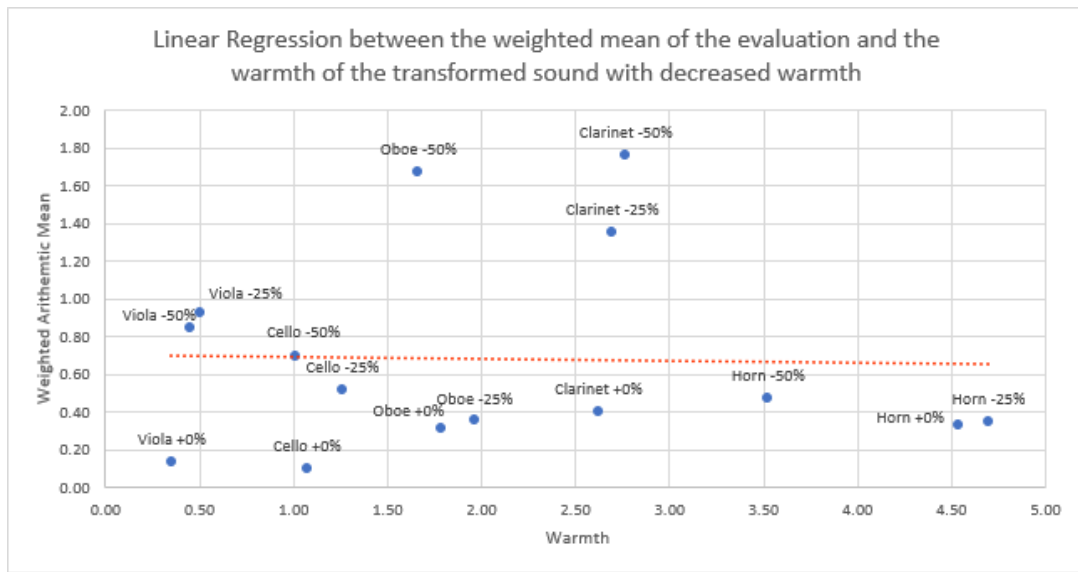

Figure A.93: Linear regression between the weighted arithmetic mean evaluation and the warmth of the sounds with decreased level of warmth

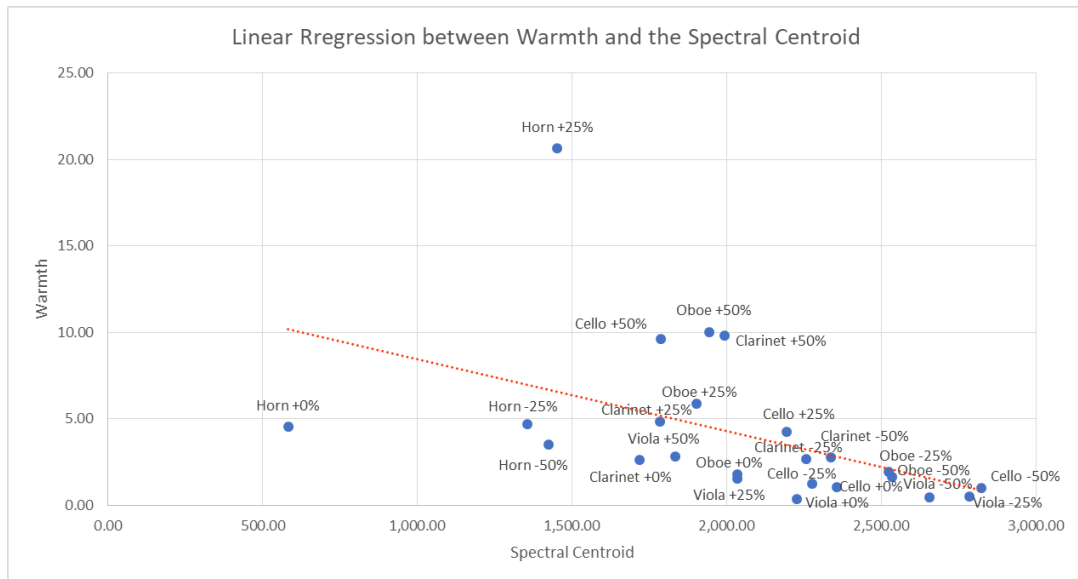

Figure A.94: Linear regression between the warmth and the spectral centroid of all transformed sounds



# References

- [1] D. Williams and T. Brookes, “Perceptually-motivated audio morphing: warmth,” in *128th Convention, London, UK*, 2010.
- [2] I. E. Y. Simurra *et al.*, “A utilização descritores de áudio á análise e composição musical assistidas por computador: um estudo de caso na obra *Labori Ruinae*,” *XXV Congresso da Associação Nacional de Pesquisa e Pós-Graduação em Música, Vitória*, 2015.
- [3] I. E. Y. Simurra, “Contribuição ao problema da orquestração assistida por computador com suporte de descritores de áudio,” Ph.D. dissertation, Univeridade Estadual de Campinas, 2016.
- [4] M. Schedl, E. Gómez, J. Urbano *et al.*, “Music information retrieval: Recent developments and applications,” *Foundations and Trends® in Information Retrieval*, vol. 8, no. 2-3, pp. 127–261, 2014.
- [5] J. S. Downie, D. Byrd, and T. Crawford, “Ten years of ismir: Reflections on challenges and opportunities.” in *ISMIR*, 2009, pp. 13–18.
- [6] A. Antoine, D. Williams, and E. Miranda, “Towards a timbre classification system for orchestral excerpts,” in *2nd AES Workshop on Intelligent Music Production*, September 2016. [Online]. Available: <http://goo.gl/YkdOA6>
- [7] U. Zölzer, *Digital audio signal processing*. John Wiley & Sons, 2008.
- [8] M. Kuhn, “Digital signal processing,” 2009. [Online]. Available: <http://www.cl.cam.ac.uk/teaching/0809/DSP/slides.pdf>
- [9] M. Rizk and A. Wassal, “Asic implementation of tms320c2x dsp as a second phase of cordoba dsp,” 2014.
- [10] J. Macêdo Fechine Régis de Araújo, “Processamento digital de sinais: Conceitos e aplicações,” 2012. [Online]. Available: <https://goo.gl/i9hEAw>
- [11] J. Futrelle and J. S. Downie, “Interdisciplinary communities and research issues in music information retrieval.” in *ISMIR*, vol. 2, 2002, pp. 215–221.

- [12] D. Moffat, D. Ronan, J. D. Reiss *et al.*, “An evaluation of audio feature extraction toolboxes,” 2015.
- [13] A. Wang *et al.*, “An industrial strength audio search algorithm.” in *Ismir*, vol. 2003. Washington, DC, 2003, pp. 7–13.
- [14] M. S. Lew, N. Sebe, C. Djeraba, and R. Jain, “Content-based multimedia information retrieval: State of the art and challenges,” *ACM Trans. Multimedia Comput. Commun. Appl.*, vol. 2, no. 1, pp. 1–19, Feb. 2006. [Online]. Available: <http://doi.acm.org/10.1145/1126004.1126005>
- [15] P. Herrera, X. Serra, and G. Peeters, “Audio descriptors and descriptor schemes in the context of mpeg-7.” in *ICMC*, 1999.
- [16] A. Friberg, E. Schoonderwaldt, A. Hedblad, M. Fabiani, and A. Elowsson, “Using listener-based perceptual features as intermediate representations in music information retrieval,” *The Journal of the Acoustical Society of America*, vol. 136, no. 4, pp. 1951–1963, 2014.
- [17] D. Schwarz, “A system for data-driven concatenative sound synthesis,” in *Digital Audio Effects (DAFx)*, 2000, pp. 97–102.
- [18] E. G. Gutiérrez, “Tonal description of music audio signals,” Ph.D. dissertation, Universitat Pompeu Fabra, 2006.
- [19] F. Gouyon, P. Herrera, E. Gómez, P. Cano, J. Bonada, A. Loscos, X. Amatriain, and X. Serra, *Content Processing of Music Audio Signals*. Berlin: Logos Verlag Berlin GmbH, 2008.
- [20] G. Bernardes, “Composing music by selection: Content-based algorithmic-assisted audio composition,” Ph.D. dissertation, PhD dissertation, University of Porto, 2014.
- [21] E. Schubert, J. Wolfe, and A. Tarnopolsky, “Spectral centroid and timbre in complex, multiple instrumental textures,” in *Proceedings of the international conference on music perception and cognition, North Western University, Illinois*. Citeseer, 2004, pp. 112–116.
- [22] D. Bolger and N. Griffith, “Multidimensional timbre analysis of shakuhachi honkyoku,” in *Proceedings of the Conference on International Musicology*, 2005.
- [23] H. Fastl and E. Zwicker, *Psychoacoustics: facts and models*. Springer Science & Business Media, 2006, vol. 22.
- [24] M. A. Landera and R. Shrivastav, “Effects of spectral slope on perceived breathiness in vowels,” *The Journal of the Acoustical Society of America*, vol. 119, no. 5, pp. 3339–3340, 2006.

- [25] G. Peeters, B. L. Giordano, P. Susini, N. Misdariis, and S. McAdams, “The timbre toolbox: Extracting audio descriptors from musical signals,” *The Journal of the Acoustical Society of America*, vol. 130, no. 5, pp. 2902–2916, 2011.
- [26] M. Malt and E. Jourdan, “Zsa. descriptors: a library for real-time descriptors analysis,” *Sound and Music Computing, Berlin, Germany*, 2008.
- [27] J. Krimphoff, “Analyse acoustique et perception du timbre [acoustic analysis and perception of timbre] unpublished master’s thesis,” *Université du Maine, Le Mans, France*, 1993.
- [28] E. Scheirer and M. Slaney, “Construction and evaluation of a robust multifeature speech/music discriminator,” in *Acoustics, Speech, and Signal Processing, 1997. ICASSP-97., 1997 IEEE International Conference on*, vol. 2. IEEE, 1997, pp. 1331–1334.
- [29] H. F. Pollard and E. V. Jansson, “A tristimulus method for the specification of musical timbre,” *Acta Acustica united with Acustica*, vol. 51, no. 3, pp. 162–171, 1982.
- [30] T. Brookes and D. Williams, “Perceptually-motivated audio morphing: Brightness,” in *Audio Engineering Society Convention 122*. Audio Engineering Society, 2007.
- [31] D. Williams and T. Brookes, “Perceptually-motivated audio morphing: softness,” in *Audio Engineering Society Convention 126*. Audio Engineering Society, 2009.
- [32] J.-M. Jot and O. Warusfel, “Spat: A spatial processor for musicians and sound engineers,” in *CIARM: International Conference on Acoustics and Musical Research*, 1995.
- [33] R. Ethington and B. Punch, “Seawave: A system for musical timbre description,” *Computer Music Journal*, vol. 18, no. 1, pp. 30–39, 1994.
- [34] D. Schwarz, G. Lemaitre, M. Aramaki, and R. Kronland-Martinet, “Effects of test duration in subjective listening tests,” in *International Computer Music Conference (ICMC)*. HKU University of the Arts Utrecht, HKU Music and Technology, 2016, pp. 515–519.
- [35] M. Puckette *et al.*, “Pure data: another integrated computer music environment,” *Proceedings of the second intercollege computer music concerts*, pp. 37–41, 1996.